

Alienware 16 Aurora

AC16250

Owner's Manual

Notes, cautions, and warnings

 **NOTE:** A NOTE indicates important information that helps you make better use of your product.

 **CAUTION:** A CAUTION indicates either potential damage to hardware or loss of data and tells you how to avoid the problem.

 **WARNING:** A WARNING indicates a potential for property damage, personal injury, or death.

Chapter 1: Views of Alienware 16 Aurora AC16250	7
Right	7
Left	7
Front	8
Top	9
Back	10
Bottom	11
Locate the Service Tag or Express Service Code label of your computer	11
Battery-charge status light	12
Chapter 2: Set up your Alienware 16 Aurora AC16250	13
Chapter 3: Specifications of Alienware 16 Aurora AC16250	14
Dimensions and weight	14
Processor	14
Chipset	15
Operating system	15
Memory	15
External ports and slots	16
Internal slots	17
Ethernet	17
Wireless module	17
Audio	18
Storage	18
Keyboard	18
Keyboard shortcuts	19
Camera	21
Touchpad	21
Power adapter	21
Power adapter requirements	22
Battery	23
Power requirements (for computers shipped with 3-cell, 60 Wh battery)	24
Power requirements (for computers shipped with 6-cell, 96 Wh battery)	24
Display	25
GPU—Integrated	25
GPU—Discrete	26
External display support	26
Enabling G-SYNC	26
Operating and storage environment	27
Dell support policy	27
Dell low blue light display	27
Chapter 4: Alienware Command Center	29

Chapter 5: Working inside your computer.....	30
Safety instructions.....	30
Before working inside your computer.....	30
Safety precautions.....	31
Electrostatic discharge—ESD protection.....	31
ESD Field Service kit	32
Transporting sensitive components.....	33
After working inside your computer.....	33
Information on reparability for Québec - From Dell Canada Inc. - to Quebec consumers.....	33
BitLocker.....	33
Recommended tools.....	34
Screw list.....	34
Major components of Alienware 16 Aurora AC16250.....	35
Chapter 6: Removing and installing Customer Replaceable Units (CRUs).....	38
Base cover.....	38
Removing the base cover.....	38
Installing the base cover.....	42
Battery.....	45
Rechargeable Li-ion battery precautions.....	45
Removing the 3-cell battery.....	46
Installing the 3-cell battery.....	47
Removing the 6-cell battery.....	48
Installing the 6-cell battery.....	49
Battery cable.....	50
Removing the 3-cell battery cable.....	50
Installing the 3-cell battery cable.....	51
Removing the 6-cell battery cable.....	52
Installing the 6-cell battery cable.....	53
Memory module.....	54
Removing the memory module.....	54
Installing the memory module.....	55
Solid-state drive.....	56
Removing the M.2 2230 SSD in the SSD1 slot.....	56
Installing the M.2 2230 SSD in the SSD1 slot.....	57
Removing the M.2 2230 SSD in the SSD2 slot.....	58
Installing the M.2 2230 SSD in the SSD2 slot.....	59
Wireless card.....	60
Removing the wireless card.....	60
Installing the wireless card.....	61
Speakers.....	63
Removing the speakers.....	63
Installing the speakers.....	63
Chapter 7: Removing and installing Field Replaceable Units (FRUs).....	65
Power-adaptor port.....	65
Removing the power-adaptor port.....	65
Installing the power-adaptor port.....	66

Fan and heat-sink assembly.....	67
Removing the fan and heat-sink assembly.....	67
Installing the fan and heat-sink assembly.....	69
USB Type-C bracket.....	70
Removing the Type-C bracket.....	70
Installing the Type-C bracket.....	71
Battery bracket.....	71
Removing the 3-cell battery brackets.....	71
Installing the 3-cell battery brackets.....	72
Removing the 6-cell battery brackets.....	73
Installing the 6-cell battery brackets.....	74
Touchpad.....	75
Removing the touchpad.....	75
Installing the touchpad.....	76
Power button and power-button board.....	77
Removing the power button and power-button board.....	77
Installing the power button and power-button board.....	79
System board.....	80
Removing the system board	80
Installing the system board	83
I/O board.....	85
Removing the I/O board.....	85
Installing the I/O board.....	86
Rear cap.....	87
Removing the rear cap.....	87
Installing the rear cap.....	88
Center bar.....	89
Removing the center bar.....	89
Installing the center bar.....	91
Display assembly.....	93
Removing the display assembly.....	93
Installing the display assembly.....	96
Palm rest and keyboard assembly.....	99
Removing the palm rest and keyboard assembly.....	99
Installing the palm rest and keyboard assembly.....	100
Chapter 8: Software.....	103
Operating system.....	103
Drivers and downloads.....	103
Chapter 9: BIOS Setup.....	104
Entering BIOS Setup program.....	104
Navigation keys.....	104
F12 One Time Boot menu.....	104
View Advanced Setup options.....	105
View Service options.....	105
BIOS Setup options.....	105
Updating the BIOS.....	120
Updating the BIOS in Windows.....	120

Updating the BIOS using the USB drive in Windows.....	121
Updating the BIOS in Linux and Ubuntu.....	121
Updating the BIOS from the One-Time boot menu.....	121
System and setup password.....	121
Assigning a System Setup password.....	122
Deleting or changing an existing system password or setup password.....	122
Clearing system and setup passwords.....	123
Chapter 10: Troubleshooting.....	124
Handling swollen rechargeable Li-ion batteries.....	124
Dell SupportAssist Pre-boot System Performance Check diagnostics.....	124
Running the SupportAssist Pre-Boot System Performance Check.....	125
Built-in self-test (BIST).....	125
Motherboard Built-In Self-Test (M-BIST).....	125
Logic Built-in Self-test (L-BIST).....	126
LCD Built-in Self-Test (LCD-BIST).....	126
System-diagnostic lights.....	126
Recovering the operating system.....	127
Real-Time Clock (RTC Reset).....	127
Backup media and recovery options.....	128
Network power cycle.....	128
Drain flea power (perform hard reset).....	128
Chapter 11: Getting help and contacting Alienware.....	130
Chapter 12: Revision history.....	131

Views of Alienware 16 Aurora AC16250

Right



Figure 1. Right view

1. Air vents

Air vents provide ventilation for your computer. Clogged air vents can cause overheating and can affect the performance of your computer and potentially cause hardware issues. Keep the air vents clear of obstructions and clean them regularly to prevent the build-up of dust and dirt. For more information about cleaning air vents, search for articles in the Knowledge Base Resource at [Dell Support Site](#).

Left

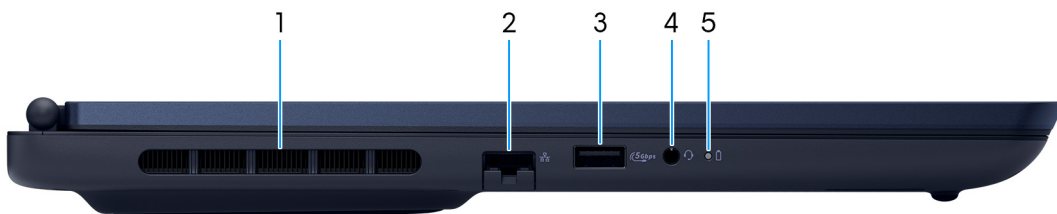

Figure 2. Left view

1. Air vents

Air vents provide ventilation for your computer. Clogged air vents can cause overheating and can affect the performance of your computer and potentially cause hardware issues. Keep the air vents clear of obstructions and clean them regularly to prevent the build-up of dust and dirt. For more information about cleaning air vents, search for articles in the Knowledge Base Resource at [Dell Support Site](#).

2. RJ45 ethernet port (1 Gbps)

Connect an RJ45 ethernet cable from a router or a broadband modem for network or Internet access, with a transfer rate of 10/100/1000 Mbps (maximum 1 Gbps).

3. USB 3.2 Gen 1 (5 Gbps) port

Connect devices such as external storage devices, printers, and external displays. Provides data transfer speeds up to 5 Gbps.

4. Universal audio jack

Connect headphones or a headset (headphone and microphone combo).

5. Battery-status light

Indicates the battery-charge status.

- Solid white: The computer is connected to the power adapter, and the battery is charging.
- Solid amber: The battery has less than 8% remaining charge.

Front



Figure 3. Front view

1. Microphones (2)

Provides digital sound input for audio recording and voice calls.

2. Camera

Enables you to video chat, capture photos, and record videos.

3. Camera-status light

Turns on when the camera is in use.

Top



Figure 4. Top view

1. Power button

Press to turn on the computer if it is turned off, in sleep state, or in hibernate state.

Press to put the computer in to sleep state if it is turned on.

Press and hold to force shut-down the computer.

2. Right-click area

Press to right-click.

3. Left-click area

Press to left-click.

4. Touchpad

Move your finger on the touchpad to move the mouse pointer. Tap with a finger to left-click and tap with two fingers to right-click.

Back



Figure 5. Back view

1. Air vents

Air vents provide ventilation for your computer. Clogged air vents can cause overheating and can affect the performance of your computer and potentially cause hardware issues. Keep the air vents clear of obstructions and clean them regularly to prevent the build-up of dust and dirt. For more information about cleaning air vents, search for articles in the Knowledge Base Resource at [Dell Support Site](#).

2. USB 3.2 Gen 1 (5 Gbps) port

Connect devices such as external storage devices, printers, and external displays. Provides data transfer speeds up to 5 Gbps.

3. USB 3.2 Gen 2 (10 Gbps) port with DisplayPort/Power Delivery

Connect devices such as external storage devices, printers, and external displays. Provides data transfer rate of up to 10 Gbps.

Supports Power Delivery that enables two-way power supply between devices.

Supports DisplayPort 1.4a and also enables you to connect an external display using a display adapter. Depending on the types of ports available on selected Alienware monitors, a display adapter may not be required.

NOTE: A USB Type-C to DisplayPort adapter (sold separately) may be required to connect a DisplayPort device depending on the display you are connecting to.

4. USB 3.2 Gen 2 (10 Gbps) port with DisplayPort

Connect devices such as external storage devices, printers, and external displays. Provides data transfer rate of up to 10 Gbps.

Supports DisplayPort 1.4a and also enables you to connect an external display using a display adapter. Depending on the types of ports available on selected Alienware monitors, a display adapter may not be required.

NOTE: A USB Type-C to DisplayPort adapter (sold separately) may be required to connect a DisplayPort device depending on the display you are connecting to.

5. HDMI 2.1 port with Discrete Graphics Controller Direct Output

Connect to an external display, TV, or another HDMI-in enabled device. Provides video and audio output.

6. Power-adapter port

Connect a power adapter to provide power to your computer.

Bottom



Figure 6. Bottom view

1. Speakers

Provide audio output.

2. Air vents

Air vents provide ventilation for your computer. Clogged air vents can cause overheating and can affect the performance of your computer and potentially cause hardware issues. Keep the air vents clear of obstructions and clean them regularly to prevent the build-up of dust and dirt. For more information about cleaning air vents, search for articles in the Knowledge Base Resource at [Dell Support Site](#).

3. Service Tag label

The Service Tag is a unique alphanumeric identifier that enables Dell service technicians to identify the hardware components in your computer and access warranty information.

4. MyAlienware QR code

MyAlienware is your hub for content personalized to your Alienware 16 Aurora AC16250, including videos, articles, manuals, and easy access to support.

Locate the Service Tag or Express Service Code label of your computer

The service tag is a unique alphanumeric identifier that allows Dell service technicians to identify the hardware components in your computer and access warranty information. The Express Service Code is a numeric version of the Service Tag.

For more information about how to find the Service Tag of your computer, search in the Knowledge Base Resource at the [Dell Support Site](#).



Figure 7. Service Tag/Express Service Code location

Battery-charge status light

The following table lists the battery-charge status light of your Alienware 16 Aurora AC16250.

Table 1. Battery charge and status light behavior

Power source	LED behavior	System power state	Battery charge level
AC adapter	Off	S0 or S5	Fully charged
AC adapter	Solid white	S0 or S5	< Fully charged. The battery is charging.
Battery	Off	S0 or S5	9%-100%
Battery	Solid amber (590+/-3 nm)	S0	< 8%

- S0 (ON): The computer is turned on.
- S4 (Hibernate): The computer consumes the least power in the Hibernated state than in the ON or OFF state. The computer is almost in the OFF state. The context data is written to a storage device, allowing you to resume from where you left when the computer is turned on.
- S5 (OFF): The computer is in a shutdown state.

Set up your Alienware 16 Aurora AC16250

About this task

NOTE: The images in this document may differ from your computer depending on the configuration you ordered.

Steps

Connect the power adapter and press the power button.



Figure 8. Connect the power adapter and press the power button

Specifications of Alienware 16 Aurora AC16250

Dimensions and weight

The following table lists the height, width, depth, and weight of your Alienware 16 Aurora AC16250.

Table 2. Dimensions and weight

Description	Values
Height:	
Front height	18.61 mm (0.73 in.)
Rear height	15.20 mm (0.60 in.)
Width	356.98 mm (14.05 in.)
Depth	265.43 mm (10.45 in.)
Weight	2.49 kg (5.49 lb) - (minimum)
 NOTE: The weight of your computer depends on the configuration that you ordered.	

Processor

The following table lists the details of the processors that are supported in your Alienware 16 Aurora AC16250.

Table 3. Processor

Description	Option one	Option two	Option three
Processor type	Intel Core 5 Processor 210H	Intel Core 7 Processor 240H	Intel Core 9 Processor 270H
Processor wattage	45	45	45
Processor total core count	8	10	14
Performance-cores	4	6	6
Efficient-cores	4	4	8
Processor total thread counts	12	16	20
 NOTE: Intel Hyper-Threading Technology is only available on Performance-cores.			
Processor speed	Up to 4.8 GHz	Up to 5.2 GHz	Up to 5.8 GHz
Performance-cores frequency			

Table 3. Processor (continued)

Description		Option one	Option two	Option three
	Processor base frequency	2.2 GHz	2.5 GHz	2.7 GHz
	Maximum turbo frequency	4.8 GHz	5.2 GHz	5.8 GHz
Efficient-cores frequency				
	Processor base frequency	1.6 GHz	1.8 GHz	2.0 GHz
	Maximum turbo frequency	3.6 GHz	4.0 GHz	4.1 GHz
Processor cache		12 MB	24 MB	24 MB
Integrated graphics		Intel Graphics	Intel Graphics	Intel Graphics

Chipset

The following table lists the details of the chipset that is supported in your Alienware 16 Aurora AC16250.

Table 4. Chipset

Description	Option one	Option two	Option three
Processors	Intel Core 5 processor 210H	Intel Core 7 processor 240H	Intel Core 9 processor 270H
Chipset	Integrated with the processor	Integrated with the processor	Integrated with the processor
DRAM bus width	64-bit	64-bit	64-bit
Flash EPROM	16 MB	16 MB	16 MB
PCIe bus	Up to Gen 4.0	Up to Gen 4.0	Up to Gen 4.0

Operating system

Your Alienware 16 Aurora AC16250 supports the following operating systems:

- Windows 11 Home (64-bit)
- Windows 11 Professional (64-bit)
- Ubuntu Linux 24.04 LTS

Memory

The following table lists the memory specifications that are supported by your Alienware 16 Aurora AC16250.

 **NOTE:** The memory configuration available depends on the country or region that the computer is purchased in.

Table 5. Memory specifications

Description	For computers shipped with Intel Core i5 processors and NVIDIA GeForce RTX 3050 and 4050 GPUs:	For computers shipped with Intel Core i7 processors and NVIDIA GeForce RTX 3050 and 4050 GPUs:	For computers shipped with NVIDIA GeForce RTX 5050, 5060, and 5070 GPUs:
Memory slots	Two SO-DIMM slots	Two SO-DIMM slots	Two SO-DIMM slots
Memory type	DDR5	DDR5	DDR5
Memory speed	5200 MT/s	5600 MT/s	5600 MT/s
Maximum memory configuration	32 GB	32 GB	32 GB
Minimum memory configuration	8 GB	8 GB	8 GB
Memory size per slot	8 GB, 16GB, and 32 GB	8 GB, 16GB, and 32 GB	8 GB, 16 GB, and 32 GB
Memory configurations supported	<ul style="list-style-type: none"> 8 GB, 1 x 8 GB, DDR5, 5200 MT/s 16 GB, 1 x 16 GB, DDR5, 5200 MT/s (for computers shipped to China) 16 GB, 2 x 8 GB, DDR5, 5200 MT/s, dual-channel 32 GB, 2 x 16 GB, DDR5, 5600 MT/s, dual-channel 	<ul style="list-style-type: none"> 8 GB, 1 x 8 GB, DDR5, 5600 MT/s 16 GB, 1 x 16 GB, DDR5, 5600 MT/s (for computers shipped to China) 16 GB, 2 x 8 GB, DDR5, 5600 MT/s, dual-channel 32 GB, 2 x 16 GB, DDR5, 5600 MT/s, dual-channel 	<ul style="list-style-type: none"> 8 GB, 1 x 8 GB, DDR5, 5600 MT/s 16 GB, 1 x 16 GB, DDR5, 5600 MT/s (for computers shipped to China) 16 GB, 2 x 8 GB, DDR5, 5600 MT/s, dual-channel 32 GB, 2 x 16 GB, DDR5, 5600 MT/s, dual-channel

External ports and slots

The following table lists the external ports and slots on your Alienware 16 Aurora AC16250.

Table 6. External ports and slots

Description	Values
Network port	One RJ45 ethernet port (1 Gbps)
USB ports	<ul style="list-style-type: none"> Two USB 3.2 Gen 1 (5 Gbps) port One USB 3.2 Gen 2 (10 Gbps) port with DisplayPort/Power Delivery One USB 3.2 Gen 2 (10 Gbps) port with DisplayPort
Audio port	One universal audio jack (RCA, 3.5 mm)
Video port(s)	One HDMI 2.1 port with Discrete Graphics Controller Direct Output
Media-card reader	Not supported
Power-adaptor port	One 7.4 mm x 5.1 mm, DC-in
Security-cable slot	Not supported

Internal slots

The following table lists the internal slots of your Alienware 16 Aurora AC16250.

Table 7. Internal slots

Description	Values
M.2	Two M.2 2230 solid state drive slots  NOTE: To learn more about the features of different types of M.2 cards, search Dell Support Site .

Ethernet

The following table lists the wired ethernet Local Area Network (LAN) specifications of your Alienware 16 Aurora AC16250.

Table 8. Ethernet specifications

Description	Values
Model	Realtek RTL8111H Gigabit Ethernet controller
Transfer rate	1000 Mbps for Ethernet controller

Wireless module

The following table lists the Wireless Local Area Network (WLAN) module that is supported on your Alienware 16 Aurora AC16250.

Table 9. Wireless module specifications

Description	Values
Model number	MediaTek MT7925B22M
Transfer rate	Up to 2882 Mbps
Frequency bands supported	2.4 GHz/ 5 GHz/ 6 GHz
Wireless standards	<ul style="list-style-type: none">• Wi-Fi 802.11a/b/g• Wi-Fi 4 (WiFi 802.11n)• Wi-Fi 5 (WiFi 802.11ac)• Wi-Fi 6E (WiFi 802.11ax) for computers installed with Ubuntu Linux 24.04 LTS• Wi-Fi 7 (WiFi 802.11be)
Encryption	<ul style="list-style-type: none">• 64-bit/128-bit WEP• AES-CCMP• TKIP
Bluetooth wireless card  NOTE: The functionality of the Bluetooth wireless card may vary based on the operating system.	Bluetooth 5.4 wireless card

Audio

The following table lists the audio specifications of your Alienware 16 Aurora AC16250.

Table 10. Audio specifications

Description		Values
Audio controller		Realtek ALC3204
Stereo conversion		Supported
Internal audio interface		High-definition audio interface
External audio interface		<ul style="list-style-type: none"> One universal audio jack (RCA, 3.5 mm) One HDMI 2.1 port
Number of speakers		Two
Internal-speaker amplifier		Supported
External volume controls		Keyboard shortcut controls
Speaker output:		
	Average	2 W + 2 W = 4 W
	Peak	2.5 W + 2.5 W = 5 W
Microphone		Digital-array microphones in camera assembly

Storage

This section lists the storage options on your Alienware 16 Aurora AC16250.

Your Alienware 16 Aurora AC16250 supports two M.2 2230 solid state drive slots.

i **NOTE:** The primary drive of your Alienware 16 Aurora AC16250 varies with the storage configuration. The primary drive of your computer is the M.2 2230 drive where the operating system is installed.

i **NOTE:** If installing an additional SSD or upgrading an existing SSD, a thermal shield (with thermal pad) must be installed over the SSD as described in the SSD replacement instructions. A new thermal shield (with thermal pad) can be purchased separately from Dell.

Table 11. Storage specifications

Storage type	Interface type	Capacity
M.2 2230 solid state drive	PCIe Gen 4 x4 NVMe, up to 64 Gbps	Up to 1 TB per slot

Keyboard

The following table lists the keyboard specifications of your Alienware 16 Aurora AC16250.

Table 12. Keyboard specifications

Description	Values
Keyboard type	Backlit keyboard

Table 12. Keyboard specifications (continued)

Description	Values
Keyboard layout	QWERTY
Number of keys	<ul style="list-style-type: none"> ● English US, English International, Arabic, Korean: 101 keys ● English UK, German, French (European), Spanish (Latin America), Turkish: 102 keys ● Portuguese (Brazil): 103 keys ● Japanese: 105 keys
Key pitch	X=18.70 mm key pitch Y=18.05 mm key pitch
Keyboard shortcuts	Some keys on your keyboard have two symbols on them. These keys can be used to type alternate characters or to perform secondary functions. To type the alternate character, press Shift and the desired key. To perform secondary functions, press Fn and the desired key. ⓘ NOTE: You can define the primary behavior of the function keys (F1–F12) changing Function Key Behavior in BIOS setup program. For more information, see Keyboard shortcuts .

Keyboard shortcuts

ⓘ **NOTE:** Keyboard characters may differ depending on the keyboard language configuration. Keys that are used for shortcuts remain the same across all language configurations.

Some keys on your keyboard have two symbols on them. These keys can be used to type alternate characters or to perform secondary functions. The symbol that is shown on the lower part of the key sees the character that is typed out when the key is pressed. If you press shift and the key, the symbol that is shown on the upper part of the key is typed out. For example, if you press **2**, 2 is typed out; if you press **Shift + 2**, @ is typed out.

The keys F1-F12 at the top row of the keyboard are function keys for multimedia control, as indicated by the icon on the key. Press the function key to invoke the task represented by the icon. For example, pressing F6 disables or enables performance boost (see the table below).

However, if the function keys F1-F12 are needed for specific software applications, multimedia functionality can be disabled by pressing **fn + Esc**. Later, multimedia control can be enabled by pressing **fn** and the respective function key. For example, disable or enable performance boost by pressing **Fn + F6**.

ⓘ **NOTE:** You can also define the primary behavior of the function keys (F1–F12) by changing **Function Key Behavior** in the BIOS setup program.

Table 13. Function key primary behavior















Keys	Description
	Decrease display brightness.
	Increase display brightness.
	Disable or enable Performance Boost.
	Enable or disable AW Stealth mode. When Stealth mode is enabled, the AlienFX lighting is turned off. Performance settings change to Quiet mode.

Table 13. Function key primary behavior (continued)

Keys	Description
	 NOTE: The AlienFX lighting zone varies depending on the configuration of your computer.
	Switch to an external display.
	Adjust keyboard backlight brightness.
	Prints screen.
 + 	Disable or enable the touchpad.







Your computer comes with preprogrammable macro keys that enable you to perform multiple actions with a single keystroke.

Table 14. Macro keys

Keys	Description
	Macro keys  NOTE: You can configure modes and assign multiple tasks for the macro keys on the keyboard.
	
	

Your computer comes with dedicated keys that enable you to control specific features of the computer with a single key press.

Table 15. Keys to control specific features

Keys	Description
	Mute speakers
	Increase volume
	Decrease volume
	Copilot in Windows AI hotkey. Press Fn+Copilot hotkey to show the contextual menu.  NOTE: If Copilot in Windows is not available on your computer, pressing the Copilot key launches Windows search. For more information about Copilot in Windows, search in the Knowledge Base Resource at the Dell Support site .
	Activates the Windows Start screen when the Windows key is pressed.

Camera

The following table lists the camera specifications of your Alienware 16 Aurora AC16250.

Table 16. Camera specifications

Description		Values
Number of cameras		One
Camera type		One HD-RGB camera
Camera location		Front camera
Camera sensor type		CMOS sensor technology
Camera resolution:		
	Still image	0.92 megapixels
	Video	1280 x 720 (FHD) at 30 fps
Diagonal viewing angle		78.6 degrees

Touchpad

The following table lists the touchpad specifications of your Alienware 16 Aurora AC16250.

Table 17. Touchpad specifications

Description		Values
Touchpad resolution:		
	Horizontal	>300 DPI
	Vertical	749
Touchpad dimensions:		
	Horizontal	115 mm (4.53 in.)
	Vertical	70 mm (2.76 in.)
Touchpad gestures		For more information about the touchpad gestures that are available on: <ul style="list-style-type: none">• Windows, search Microsoft Support Site.• Ubuntu, search Ubuntu Support Site.

Power adapter

The following table lists the power adapter specifications of your Alienware 16 Aurora AC16250.

Table 18. Power-adapter specifications

Description	Option one	Option two
Type	130 W AC adapter	180 W AC adapter
Connector dimensions:		

Table 18. Power-adapter specifications (continued)

Description		Option one	Option two
	External diameter	7.40 mm	7.40 mm
	Internal diameter	5.10 mm	5.10 mm
Power-adapter dimensions:			
	Height	25.40 mm (1.00 in.)	30.00 mm (1.18 in.)
	Width	76.20 mm (3.00 in.)	76.20 mm (3.0 in.)
	Depth	154.70 mm (6.09 in.)	155.00 mm (6.10 in.)
Input voltage		100 VAC–240 V	100 VAC–240 VAC
Input frequency		50 Hz–60 Hz	50 Hz–60 Hz
Input current (maximum)		1.80 A	2.34 A
Output current (continuous)		6.67 A	9.23 A (continuous)
Rated output voltage		19.5 VDC	19.50 VDC
Temperature range:			
	Operating	0°C to 40°C (32°F to 104°F)	0°C to 40°C (32°F to 104°F)
	Storage	-40°C to 70°C (-40°F to 158°F)	-40°C to 70°C (-40°F to 158°F)
 CAUTION: Operating and storage temperature ranges may differ among components, so operating or storing the device outside these ranges may impact the performance of specific components.			

Power adapter requirements

 **NOTE:** If you did not purchase the Dell-branded power adapter that is recommended for your computer, ensure that the power adapter you use meets the following requirements.

The following table lists the power adapter requirements for your Alienware 16 Aurora AC16250.

Table 19. Power adapter requirements



Description	For computers shipped with NVIDIA GeForce 3050 and 4050 GPUs	For computers shipped with NVIDIA GeForce 5050, 5060 and 5070 GPUs
Power that is required from a power adapter to achieve optimal performance.	130 W	180 W
Power that charges the computer at a slower speed.  NOTE: A warning message may appear informing you about the use of a lower-powered adapter and slower charging speed.	Less than 130 W	Less than 180 W
Minimum power that is required from a power adapter to operate the computer and charge the battery.  NOTE: A warning message appears informing you about the use of a	90 W	

Table 19. Power adapter requirements (continued)

Description	For computers shipped with NVIDIA GeForce 3050 and 4050 GPUs	For computers shipped with NVIDIA GeForce 5050, 5060 and 5070 GPUs
lower-powered adapter and slower charging speed.		
USB Power Delivery (PD) fast charging	Supported	
ExpressCharge mode	Supported i NOTE: Ensure that the computer is connected to a 100 W power adapter for this feature to be supported.	

Battery

The following table lists the battery specifications of your Alienware 16 Aurora AC16250.

Table 20. Battery specifications

Description	Option one	Option two	
Battery type	3-cell lithium-ion (60 Wh)	6-cell lithium-ion (96 Wh) ExpressCharge Boost i NOTE: For computers shipped to the EU region, the battery supports only ExpressCharge.	
Battery voltage	11.7 VDC	11.7 VDC	
Battery weight (maximum)	0.215 kg (0.474 lb)	0.351 kg (0.77 lb)	
Battery dimensions:			
	Height	6.15 mm (0.24 in.)	7.71 mm (0.30 in.)
	Width	248.00 mm (9.76 in)	294.9 mm (11.61 in.)
	Depth	65.10 mm (2.56 in.)	77.5 mm (3.05 in.)
Temperature range:			
	Operating	<ul style="list-style-type: none"> Charging: 0°C to 45°C (32°F to 113°F) Discharging: 0°C to 70°C (32°F to 158°F) 	<ul style="list-style-type: none"> Charging: 0°C to 45°C (32°F to 113°F) Discharging: 0°C to 70°C (32°F to 158°F)
	Storage	-20°C to 60°C (-4°F to 140°F)	-20°C to 60°C (-4°F to 140°F)
Battery operating time	Varies depending on operating conditions and can significantly reduce under certain power-intensive conditions.		
Battery charging time (approximate) i NOTE: You can control the charging time, duration, start and end time, and so on, from the BIOS settings in the BIOS Advanced menu.	<ul style="list-style-type: none"> Standard Charge: 3 hours, when the computer is turned off. ExpressCharge: 2 hours, from 0% to 100% when the computer is turned off. ExpressCharge Boost: 20 minutes, from 0% to 35% when the computer is turned off. 	<ul style="list-style-type: none"> Standard Charge: 3 hours, when the computer is turned off. ExpressCharge: 2 hours, from 0% to 100% when the computer is turned off. ExpressCharge Boost: 20 minutes, from 0% to 35% when the computer is turned off. 	

Table 20. Battery specifications (continued)

Description	Option one	Option two
Coin-cell battery	Not applicable	Not applicable
<p>⚠ CAUTION: Operating and storage temperature ranges may differ among components, so operating or storing the device outside these ranges may impact the performance of specific components.</p> <p>⚠ CAUTION: Dell Technologies recommends that you charge the battery regularly for optimal power consumption.</p>		

Power requirements (for computers shipped with 3-cell, 60 Wh battery)

i **NOTE:** The information in this section is applicable to the European Union (EU) countries.

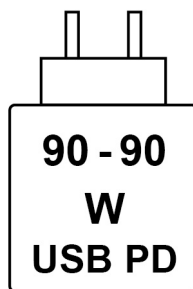

Figure 9. Pictogram for 60 Wh battery

The power that is delivered by the charger must be 90 Watts that is required by the radio equipment in order to achieve the maximum charging speed.

This computer supports USB Power Delivery (PD) fast charging.

Power requirements (for computers shipped with 6-cell, 96 Wh battery)

i **NOTE:** The information in this section is applicable to the European Union (EU) countries.

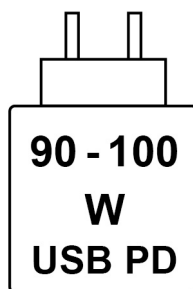

Figure 10. Pictogram for 96 Wh battery

The power that is delivered by the charger must be between a minimum of 90 Watts that is required by the radio equipment, and a maximum of 100 Watts in order to achieve the maximum charging speed.

This computer supports USB Power Delivery (PD) fast charging.

Display

The following table lists the display specifications of your Alienware 16 Aurora AC16250.

Table 21. Display specifications

Description		Values
Display type		16-inch, Wide Quad Extended Graphics Array (WQXGA), Low Blue Light
Touch options		Not supported
Display-panel technology		Wide Viewing Angle (WVA)
Display-panel dimensions (active area):		
	Height	215.42 mm (8.48 in.)
	Width	344.68 mm (13.57 in.)
	Diagonal	406.46 mm (16.00 in.)
Display-panel native resolution		2560 x 1600
Luminance (typical)		300 nits
Megapixels		4.1
Color gamut		sRGB 100% (typical)
Pixels Per Inch (PPI)		189
Contrast ratio (minimum)		1000:1
Response time (maximum)		<ul style="list-style-type: none"> • 30 ms (typical) • 35 ms (maximum)
Refresh rate		120 Hz
Horizontal view angle		+/- 85 degrees (typical)
Vertical view angle		+/- 85 degrees (typical)
Pixel pitch		0.13 mm
Power consumption (maximum)		4.80 W
Anti-glare vs glossy finish		Anti-glare

GPU—Integrated

The following table lists the specifications of the integrated Graphics Processing Unit (GPU) supported by your Alienware 16 Aurora AC16250.

Table 22. GPU—Integrated

Controller	Memory size	Processor
Intel Graphics	Shared system memory	<ul style="list-style-type: none"> • Intel Core 5 processor

Table 22. GPU—Integrated

Controller	Memory size	Processor
		<ul style="list-style-type: none">• Intel Core 7 processor• Intel Core 9 processor

GPU—Discrete

The following table lists the specifications of the discrete Graphics Processing Unit (GPU) supported by your Alienware 16 Aurora AC16250.

Table 23. GPU—Discrete

Controller	Memory size	Memory type
NVIDIA GeForce RTX 3050	6 GB	GDDR6
NVIDIA GeForce RTX 4050	6 GB	GDDR6
NVIDIA GeForce RTX 5050	8 GB	GDDR7
NVIDIA GeForce RTX 5060	8 GB	GDDR7
NVIDIA GeForce RTX 5070	8 GB	GDDR7

External display support

The following table lists the external display support for your Alienware 16 Aurora AC16250.

NOTE: Depending on the type of external display that is connected and when connected through the HDMI port., you may encounter a reduced frame rate.

Table 24. External display support

Controller	Supported external displays with laptop display enabled	Supported external displays with laptop display disabled
Intel Graphics	Supports three external displays: <ul style="list-style-type: none">• Two displays connected to the USB-C ports.• One display connected to the HDMI port (driven by the discrete GPU)	Supports four external displays: <ul style="list-style-type: none">• Three external displays, one connected to the USB 3.2 Gen 1 (5 Gbps) port, two connected to the USB-C ports.• One display connected to the HDMI port (driven by the discrete GPU)
NVIDIA GeForce RTX 3050 NVIDIA GeForce RTX 4050 NVIDIA GeForce RTX 5050 NVIDIA GeForce RTX 5060 NVIDIA GeForce RTX 5070	Supports one G-SYNC capable external display that is connected to the HDMI port. NOTE: To enable G-SYNC, see Enabling G-SYNC .	Supports one G-SYNC capable external display that is connected to the HDMI port. NOTE: To enable G-SYNC, see Enabling G-SYNC .

Enabling G-SYNC

To enable G-SYNC, switch to discrete graphics (dGPU) mode through the NVIDIA control panel or connect to a G-SYNC capable monitor. Once you are at the NVIDIA control panel, go to the settings to set up G-SYNC and follow the steps below.

1. From the NVIDIA Control Panel **navigation tree** pane, under **Display**, click **Set up G-SYNC**.

 **NOTE:** For more information about which port on your computer supports G-SYNC, see [External display support](#).

2. Select the **Enable G-SYNC, G-SYNC Compatible** check box, if not enabled earlier.
3. Depending on the applications you want to run on your computer, select **Enable for full screen mode** or **Enable for windowed and full screen mode**.
4. Select a display that you would like to enable the setting.
 - a. At **Select a display**, by selecting the display model icon.
 - b. At **Choose display specific setting**, check the **Enable settings for the selected display model** check box.

 **NOTE:** This step applies to either G-SYNC compatible displays or VRR displays that have not been validated by NVIDIA as G-SYNC Compatible.

Operating and storage environment

This table lists the operating and storage specifications of your Alienware 16 Aurora AC16250.

Airborne contaminant level: G1 as defined by ISA-S71.04-1985

Table 25. Computer environment

Description	Operating	Storage
Temperature range	0°C to 35°C (32°F to 95°F)	-40°C to 65°C (-40°F to 149°F)
Relative humidity (maximum)	10% to 90% (non-condensing)	5% to 95% (non-condensing)
Vibration (maximum)*	0.66 GRMS	Not applicable
Shock (maximum)	140 G†	Not applicable
Altitude range	-15.20 m to 3048.00 m (-49.87 ft to 10000.00 ft)	-15.20 m to 10668.00 m (-49.87 ft to 35000.00 ft)

 **CAUTION:** Operating and storage temperature ranges may differ among components, so operating or storing the device outside these ranges may impact the performance of specific components.

* Measured using a random vibration spectrum that simulates the user environment.

† Measured using a 2 ms half-sine pulse.

Dell support policy

For information about Dell support policy, search [Dell Support Site](#).

Dell low blue light display

 **WARNING:** Prolonged exposure to blue light from the display may lead to long-term effects such as eye strain, eye fatigue, or damage to the eyes.

Blue light is a color in the light spectrum which has a short wavelength and high energy. Chronic exposure to blue light, particularly from digital sources may disrupt sleep patterns and cause long-term effects such as eye strain, eye fatigue, or damage to the eyes.

The display on this computer is designed to minimize blue light and complies with TÜV Rheinland's requirement for low blue light displays.

Low blue light mode is enabled at the factory, so no further configuration is necessary.

To reduce the risk of eye strain, it is also recommended that you:

- Position the display at a comfortable viewing distance between 20 and 28 inches (50 cm and 70 cm) from your eyes.
- Blink frequently to moisten your eyes, wet your eyes with water, or apply suitable eye drops.
- Take an extended break for 20 minutes every two hours.
- Look away from your display, and gaze at a distant object at 20 ft (609.60 cm) away for at least 20 seconds during each break.

Alienware Command Center

Alienware Command Center (AWCC) provides a single interface to customize and enhance the gaming experience. The AWCC dashboard displays most recently played or added games, and provides game-specific information, themes, profiles, and access to computer settings. You can quickly access settings such as game-specific profiles and themes, lighting, macros, and audio that are critical to the gaming experience.

AWCC also supports AlienFX 2.0. AlienFX enables you to create, assign, and share game-specific lighting maps to enhance the gaming experience. It also enables you to create your own customized lighting effects and apply them to the computer or attached peripherals. AWCC embeds Peripheral Controls to ensure a unified experience and the ability to link these settings to your computer or game.

AWCC supports the following features:









- FX: Create and manage the AlienFX zones.
- Fusion: Fusion includes the ability to adjust game-specific Power Management, Sound Management, and Thermal Management features.
- Peripheral Management: Peripheral Management enables peripherals to appear in and be managed in Alienware Command Center. Supports key peripheral settings and associates with other functions such as profiles, macros, AlienFX, and game library.

AWCC also supports Sound Management, Thermal Controls, CPU, GPU, and Memory (RAM) monitoring. For more information about AWCC, see the *Alienware Command Center Online Help* or search in the Knowledge Base Resource at [Dell Support Site](#).

Working inside your computer

Safety instructions

Use the following safety guidelines to protect your computer from potential damage and to ensure your personal safety. Unless otherwise noted, each procedure in this document assumes that you have read the safety information that shipped with your computer.



-  **WARNING:** Before working inside your computer, read the safety information that is shipped with your computer. For more safety best practices, see [Dell Regulatory Compliance Home Page](#).
-  **WARNING:** Disconnect your computer from all power sources before opening the computer cover or panels. After you finish working inside the computer, replace all covers, panels, and screws before connecting your computer to an electrical outlet.
-  **WARNING:** For laptops, discharge the battery completely before removing it. Disconnect the AC power adapter from the computer and operate the computer solely on battery power—the battery is fully discharged when the computer no longer turns on when the power button is pressed.
-  **CAUTION:** To avoid damaging the computer, ensure that the work surface is flat, dry, and clean.
-  **CAUTION:** You should only perform troubleshooting and repairs as authorized or directed by the Dell technical support team. Damage due to servicing that is not authorized by Dell is not covered by your warranty.
-  **CAUTION:** Before touching anything inside your computer, ground yourself by touching an unpainted metal surface, such as the metal at the back of the computer. While you work, periodically touch an unpainted metal surface to dissipate static electricity which could harm internal components.
-  **CAUTION:** To avoid damaging the components and cards, handle them by their edges, and avoid touching the pins and the contacts.
-  **CAUTION:** When you disconnect a cable, pull it by its connector or its pull tab, not the cable itself. Some cables have connectors with locking tabs or thumbscrews that you must disengage before disconnecting the cable. When disconnecting cables, keep them evenly aligned to avoid bending the connector pins. When connecting cables, ensure that the connector on the cable is correctly oriented and aligned with the port.
-  **CAUTION:** Press and eject any installed card from the media-card reader.

Before working inside your computer

About this task

 **NOTE:** The images in this document may differ from your computer depending on the configuration you ordered.

Steps

1. Save and close all open files and exit all open applications.
2. Shut down your computer. For Windows operating system, click **Start** >  **Power** > **Shut down**.
 **NOTE:** If you are using a different operating system, see the documentation of your operating system for instructions.
3. Turn off all the attached peripherals.
4. Disconnect your computer from the electrical outlet.

5. Disconnect all attached network devices and peripherals, such as keyboard, mouse, and monitor from your computer.
6. Remove any media card and optical drive from your computer, if applicable.
7. To clean the air vents, use a soft brush and move vertically.

 **NOTE:** Do not remove the base cover or use any blower to clean the vents.

8. Enter the Service Mode.

Service Mode

Service Mode is used to cut off power without disconnecting the battery cable from the system board before conducting repairs in the computer.

 **CAUTION:** If you are unable to turn on the computer to put it into Service Mode, disconnect the battery cable. To disconnect the battery cable, follow the steps in [Removing the battery](#).

 **NOTE:** Ensure that your computer is shut down and the power adapter is disconnected.

- a. Press and hold the B key and the power button for 3 seconds, or until the Dell logo appears on the screen.
- b. If the **Owner Tag** is set, it is displayed on the screen. Press any key to continue.

 **NOTE:** If the **Owner Tag** information is not already set, the computer automatically skips this step and proceeds to enter Service Mode.

- c. If the power adapter is still connected, a message appears on the screen prompting you to disconnect it. Disconnect the power adapter, then press any key to continue.
- d. When the **System Ready For Service** message appears on the screen, press any key to proceed. The computer emits three short beeps and shuts down immediately. The computer shuts down and enters the Service Mode.

Safety precautions

This section details the primary steps to be followed before disassembling any device or component.

Observe the following safety precautions before any installation or break-fix procedures involving disassembly or reassembly:

- Turn off the computer and all attached peripherals.
- Disconnect the computer from AC power.
- Disconnect all network cables and peripherals from the computer.
- Use an ESD field service kit when working inside your computer to avoid electrostatic discharge (ESD) damage.
- Place the removed component on an anti-static mat after removing it from the computer.
- Press and hold the power button for 15 seconds to discharge the residual power in the system board.

Bonding

Bonding is a method for connecting two or more grounding conductors to the same electrical potential. This is done by using a field service electrostatic discharge (ESD) kit. When connecting a bonding wire, ensure that it is connected to bare metal and never to a painted or nonmetal surface. Ensure that the wrist strap is secure and in full contact with your skin. Remove all jewelry, watches, bracelets, or rings before grounding yourself and the equipment.

Electrostatic discharge—ESD protection

ESD is a major concern when you handle electronic components, especially sensitive components such as expansion cards, processors, memory modules, and system boards. A slight charge can damage circuits in ways that may not be obvious, such as intermittent problems or a shortened product life span. As the industry pushes for lower power requirements and increased density, ESD protection is an increasing concern.

Two recognized types of ESD damage are catastrophic and intermittent failures.

- **Catastrophic** – Catastrophic failures represent approximately 20 percent of ESD-related failures. The damage causes an immediate and complete loss of device functionality. An example of catastrophic failure is a memory module that has received a static shock and immediately generates a "No POST/No Video" symptom with a beep code that is emitted for missing or nonfunctional memory.

- **Intermittent** – Intermittent failures represent approximately 80 percent of ESD-related failures. The high rate of intermittent failures means that most of the time when damage occurs, it is not immediately recognizable. The memory module receives a static shock, but the tracing is merely weakened and does not immediately produce outward symptoms that are related to the damage. The weakened trace may take weeks or months to melt, and in the meantime may cause degradation of memory integrity, intermittent memory errors, and so on.

Intermittent failures that are also called latent or "walking wounded" are difficult to detect and troubleshoot.

Perform the following steps to prevent ESD damage:

- Use a wired ESD wrist strap that is properly grounded. Wireless anti-static straps do not provide adequate protection. Touching the chassis before handling parts does not ensure adequate ESD protection on parts with increased sensitivity to ESD damage.
- Handle all static-sensitive components in a static-safe area. If possible, use anti-static floor pads and workbench pads.
- When unpacking a static-sensitive component from its shipping carton, do not remove the component from the anti-static packing material until you are ready to install the component. Before unwrapping the anti-static packaging, use the anti-static wrist strap to discharge the static electricity from your body.

i **NOTE:** You can protect against ESD and discharge static electricity from your body by touching a metal-grounded object before you interact with anything electronic, for example, an unpainted metal surface on your computer's I/O panel. When connecting a peripheral (including handheld digital assistants) to your computer, you should always ground both yourself and the peripheral before connecting it to the computer. In addition, as you work inside the computer, periodically touch a metal-grounded object to remove any static charge that your body may have accumulated.

For more information about the wrist strap and ESD wrist strap tester, see [Components of an ESD Field Service Kit](#).

- Before transporting a static-sensitive component, place it in an anti-static container or packaging.

ESD Field Service kit

The unmonitored field service kit is the most commonly used service kit. Each Field Service kit includes three main components: anti-static mat, wrist strap, and bonding wire.

⚠ CAUTION: It is critical to keep ESD-sensitive devices away from internal parts that are insulated and often highly charged, such as plastic heat sink casings.

Working environment

Before the ESD Field Service kit is deployed, conduct an evaluation of the site to ensure proper setup and readiness. For example, deploying the kit for a server environment is different than for a desktop or laptop environment. Servers are typically installed in a rack within a data center; desktops or laptops are typically placed on office desks or cubicles. Always look for a large open flat work area that is free of clutter and large enough to deploy the ESD kit with additional space to accommodate the type of computer that is being repaired. The workspace should also be free of insulators that can cause an ESD event. On the work area, insulators such as styrofoam and other plastics should always be moved at least 12 inches or 30 centimeters away from sensitive parts before physically handling any hardware components.

ESD packaging

All ESD-sensitive devices must be shipped and received in static-safe packaging. Metal, static-shielded bags are preferred. However, you should always return the damaged component using the same ESD bag and packaging that the new part arrived in. The ESD bag should be folded over and taped shut and all the same foam packing material should be used in the original box that the new part arrived in. ESD-sensitive devices should be removed from packaging only at an ESD-protected work surface, and parts should never be placed on top of the ESD bag because only the inside of the bag is shielded. Always place parts in your hand, on the anti-static mat, in the computer, or inside an ESD bag.

Components of an ESD Field Service kit

The components of an ESD Field Service kit are:

- **Anti-Static Mat** – The anti-static mat is dissipative and parts can be placed on it during service procedures. When using an anti-static mat, your wrist strap should be snug and the bonding wire should be connected to the anti-static mat and to any bare metal on the computer being worked on. Once deployed properly, service parts can be removed from the ESD bag and

placed directly on the anti-static mat. ESD-sensitive items are safe in your hand, on the anti-static mat, in the computer, or inside an ESD bag.

- **Wrist Strap and Bonding Wire** – If an anti-static mat is not being used, the wrist strap and bonding wire should be connected directly between your wrist and an exposed metal part of the hardware. If you are using an anti-static mat, connect the wrist strap and bonding wire to the anti-static mat to ensure protection for any hardware placed on the mat. The physical connection of the wrist strap and bonding wire between your skin, the anti-static mat, and the hardware is known as bonding. Use only Field Service kits with a wrist strap, anti-static mat, and bonding wire. Never use wireless wrist straps. Always be cautious that the internal wires of a wrist strap are prone to damage from normal wear and tear, and must be checked regularly with a wrist strap tester in order to avoid accidental ESD hardware damage. It is recommended to test the wrist strap and bonding wire at least once per week.
- **ESD Wrist Strap Tester** – The wires inside an ESD strap are prone to damage over time. When using an unmonitored ESD kit, it is recommended to test the wrist strap regularly—ideally before each service session, and at a minimum, once per week. The most reliable method for testing is with a wrist strap tester. To perform the test, connect the bonding wire of the wrist strap to the tester while wearing the strap. Press the test button to initiate the check. A green LED indicates a successful test, while a red LED and audible alarm signal a failure.

NOTE: It is recommended to always use the traditional wired ESD grounding wrist strap and protective anti-static mat when servicing Dell products. In addition, it is critical to keep sensitive parts separate from all insulator parts while servicing the computer.

Transporting sensitive components

When transporting ESD sensitive components such as replacement parts or parts to be returned to Dell, it is critical to place these parts in anti-static bags for safe transport.

After working inside your computer

About this task

CAUTION: Leaving stray or loose screws inside your computer may severely damage your computer.

Steps

1. Replace all screws and ensure that no stray screws remain inside your computer.
2. Connect any external devices, peripherals, or cables you removed before working on your computer.
3. Replace any media cards, disks, or any other parts that you removed before working on your computer.
4. Connect your computer to their electrical outlets.

NOTE: To exit service mode, ensure to connect the AC adapter to the power-adapter port on your computer.

5. Press the power button to turn on the computer.

Information on repairability for Québec - From Dell Canada Inc. - to Quebec consumers

Dell does not guarantee the availability of replacement parts, repair services, or information necessary for maintenance or repair.

BitLocker

When updating the BIOS on a computer with BitLocker enabled, consider the following precautions.

CAUTION: If BitLocker is not suspended before updating the BIOS, the BitLocker key will not be recognized the next time that you reboot the computer. You are prompted to enter the recovery key to progress, and the computer displays a prompt for the recovery key on each reboot. If the recovery key is not known, this can

result in data loss or an operating system reinstall. For more information, see Knowledge Article: [updating the BIOS on Dell computers with BitLocker enabled](#).

The installation of the following components triggers BitLocker:

- Hard disk drive or solid state drive
- System board

Recommended tools

The procedures in this document may require the following tools:

- Phillips screwdriver #0
- Plastic scribe

Screw list

- i** **NOTE:** When removing screws from a component, it is recommended to note the screw type and the quantity of screws, and then place them in a screw storage box. This is to ensure that the correct number of screws and correct screw type is restored when the component is replaced.
- i** **NOTE:** Some computers have magnetic surfaces. Ensure that the screws are not left attached to such surfaces when replacing a component.
- i** **NOTE:** Screw color may vary depending on the configuration ordered.

Table 26. Screw list



















Component	Screw type	Quantity	Screw image
Base cover	M2x8 (captive screws)	2	
	M2x6	8	
Battery	M2x4	<ul style="list-style-type: none">• For 3-cell battery: 4• For 6-cell battery: 7	
Battery bracket A	M2x2.5	2	
Battery bracket B	M2x2.5	2	
Solid state drive	M1.6x2.9	2	
Wireless-card bracket	M2x3	1	
Touchpad	M2x2	4	
Touchpad support plate	M2x2	4	
System board	M2x3	10	
I/O board	M2x2	2	

Table 26. Screw list (continued)

Component	Screw type	Quantity	Screw image
Power-adaptor port	M2x3	2	
Type-C bracket	M2x4	3	
Fan and heat-sink assembly	M2x4	6	
Power button and power-button board	M2x2	3	
Hinge bracket (on palm rest and keyboard assembly)	M2.5x5	4	
Rear cap	M2.x3.5	5	
Center cap	M2.x3.5	2	
Display assembly	M2.5x5	4	

Major components of Alienware 16 Aurora AC16250

The following image shows the major components of Alienware 16 Aurora AC16250.

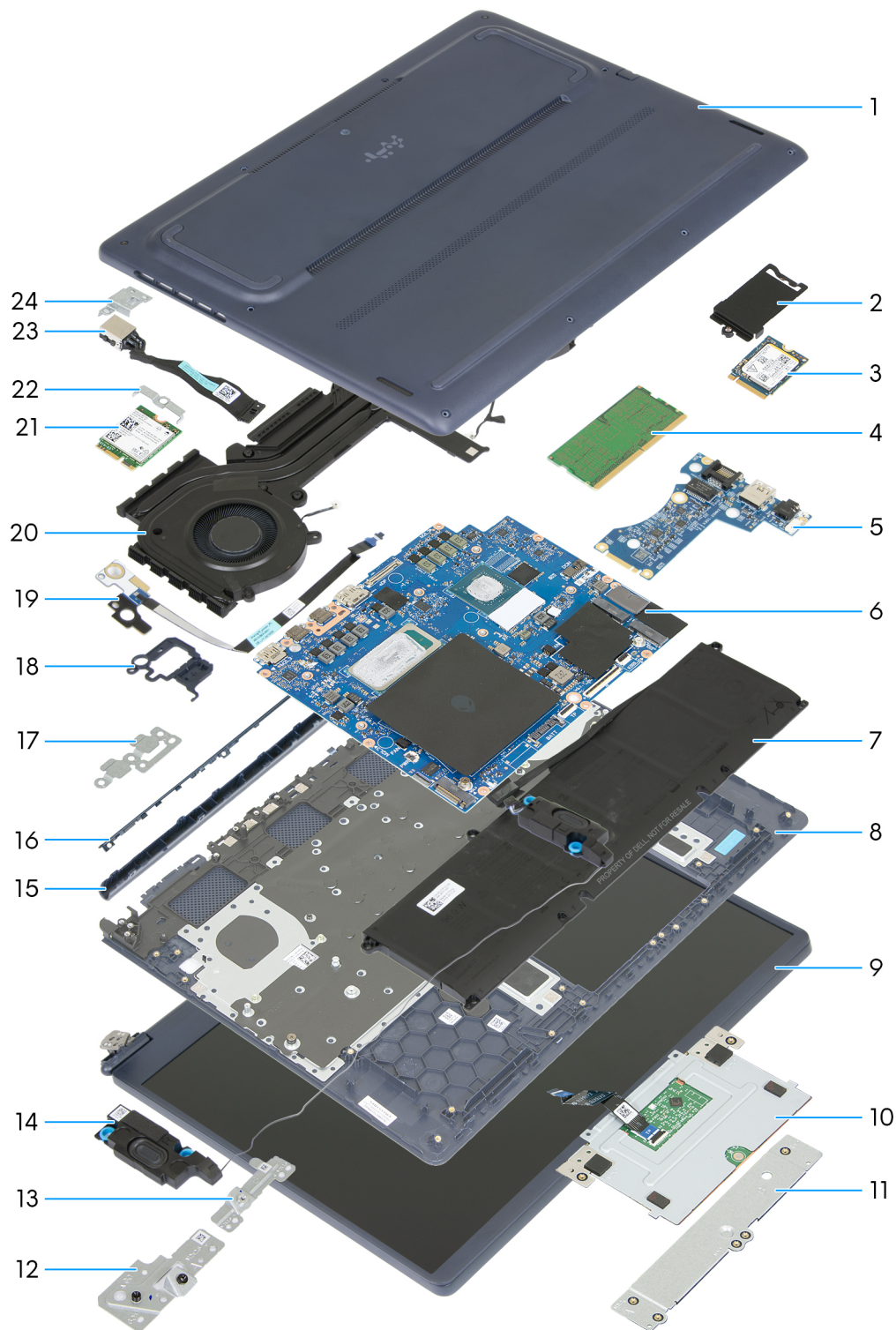

1. Base cover
2. Solid state drive (SSD) thermal shield
3. Solid state drive (SSD)
4. Memory module
5. I/O board
6. System board
7. Battery
8. Palm rest and keyboard assembly
9. Display assembly

10. Touchpad
11. Touchpad support plate
12. Battery bracket A
13. Battery bracket B
14. Speakers
15. Center bar
16. Rear cap
17. USB Type-C bracket
18. Power button
19. Power-button board
20. Fan and heat-sink assembly
21. Wireless card
22. Wireless-card bracket
23. Power-adaptor port cable
24. Power-adaptor port bracket

 **NOTE:** Dell provides a list of components and their part numbers for the original computer configuration purchased. These parts are available according to warranty coverage purchased by the customer. Contact your Dell sales representative for purchase options.

Removing and installing Customer Replaceable Units (CRUs)

The replaceable components in this chapter are Customer Replaceable Units (CRUs).

 **CAUTION:** Customers can replace only the Customer Replaceable Units (CRUs) following the safety precautions and replacement procedures.

 **NOTE:** The images in this document may differ from your computer depending on the configuration you ordered.

Base cover

Removing the base cover

Prerequisites

1. Follow the procedure in [Before working inside your computer](#).

 **NOTE:** Ensure that your computer is in Service Mode. For more information, see [Before working inside your computer](#).

 **CAUTION:** If the computer does not turn on, does not enter Service Mode, or does not support Service mode, proceed to disconnect the battery cable.

About this task

The following images indicate the location of the base cover and provide a visual representation of the removal procedure.



Figure 11. Removing the eight screws on the base cover



Figure 12. Loosening the captive screws on the base cover

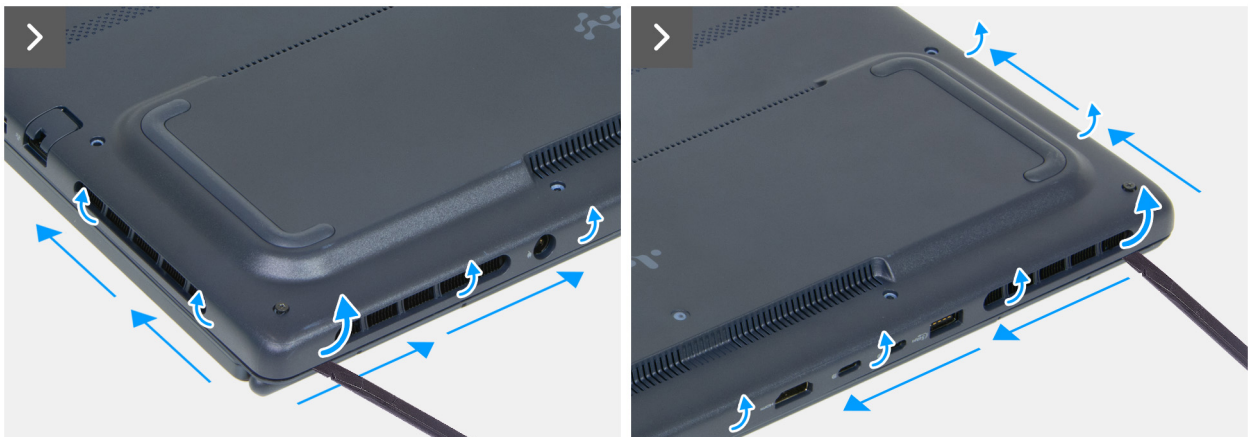

Figure 13. Inserting the scribe between the gap



Figure 14. Removing the base cover

Steps

1. Remove the eight screws (M2x6) that secure the base cover to the palm rest and keyboard assembly.
2. Loosen the two captive screws (M2x8) that secure the base cover to the palm rest and keyboard assembly.
 - i** **NOTE:** After the captive screws are loosened, the base cover is pushed upwards, creating a gap from which you can start the prying process of the base cover.
3. Insert a scribe in the gap between the base and palm rest assembly. Pry loose the base cover near the locations of the captive screws and continue to work towards the sides to open the base cover.
4. Lift the base cover off the palm rest and keyboard assembly.
 - i** **NOTE:** Ensure that your computer is in [Service Mode](#). If your computer is unable to enter Service Mode, peel off the tape and disconnect the battery cable from the battery-cable connector (BATT1) on the system board. Press and hold the power button for five seconds to ground the computer and drain the flea power.

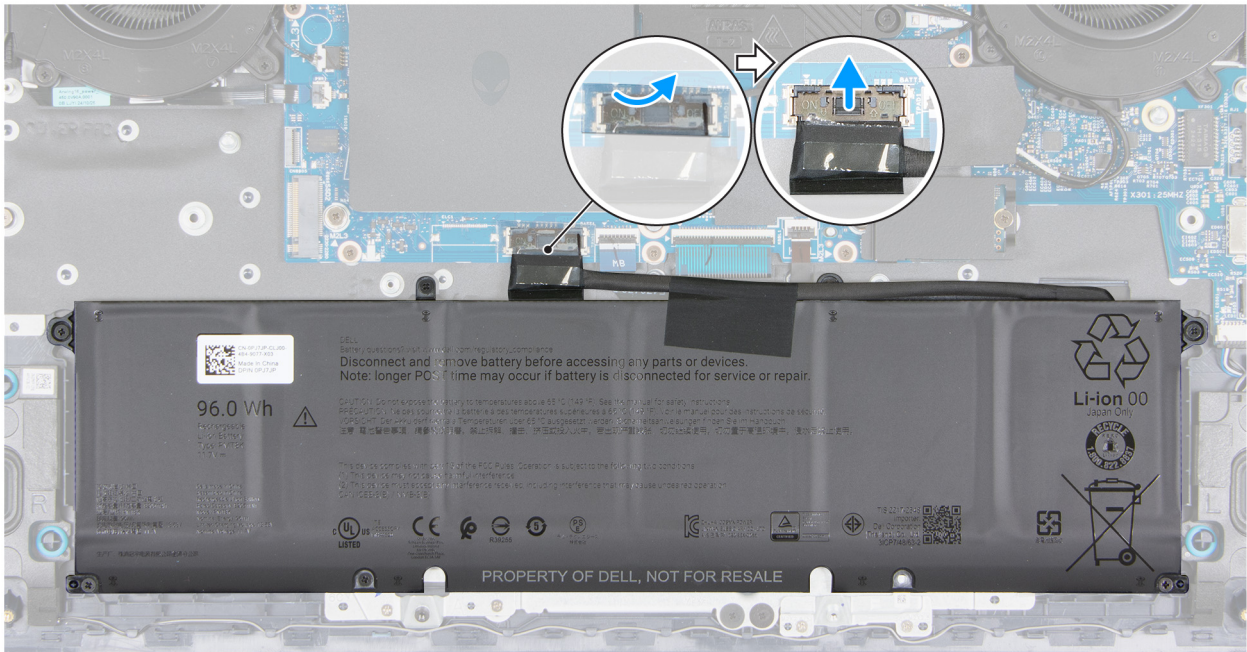
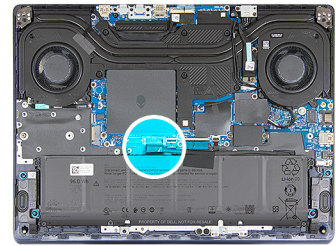

Figure 15. Disconnecting the battery cable

Installing the base cover

Prerequisites

If you are replacing a component, remove the existing component before performing the installation procedure.

About this task

The following images indicate the location of the base cover and provide a visual representation of the installation procedure.

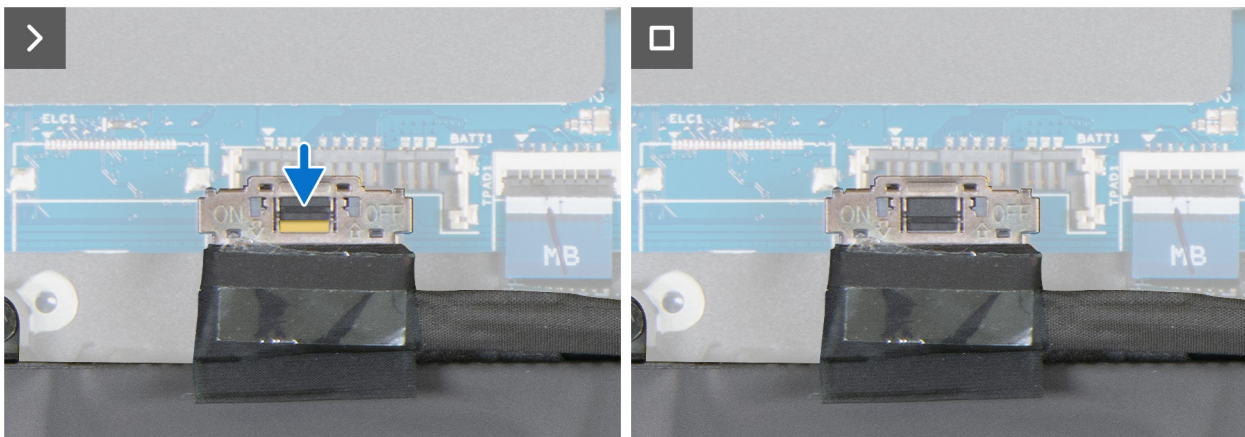

Figure 16. Restoring power from the battery

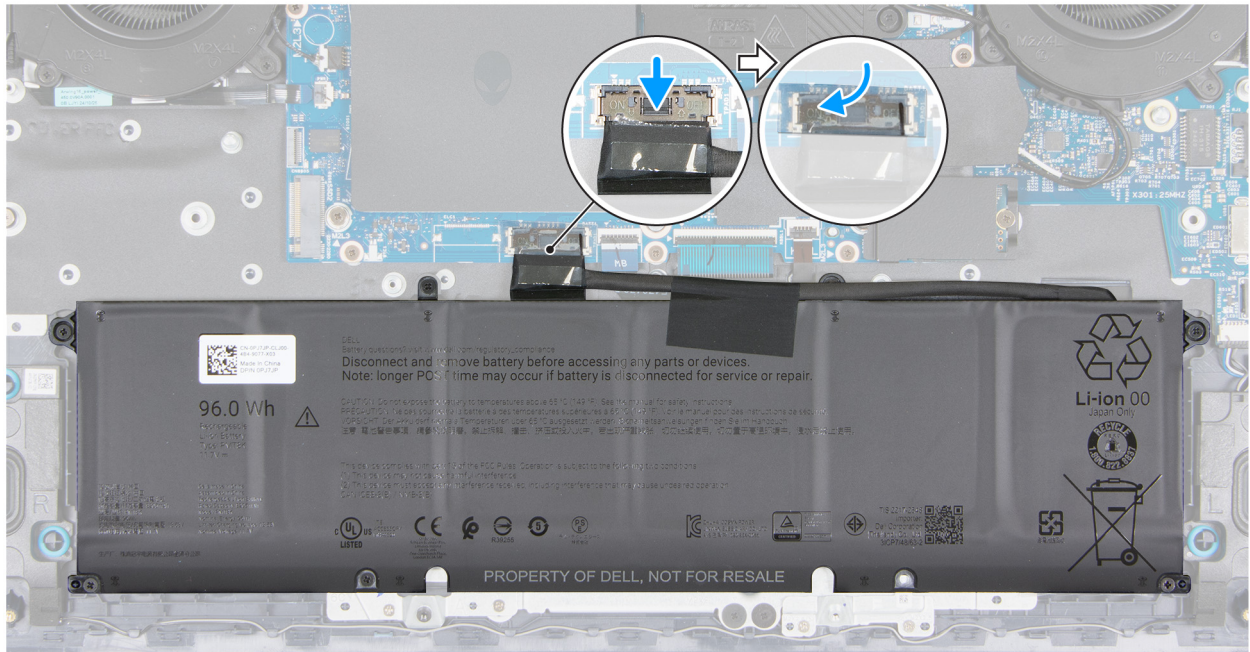
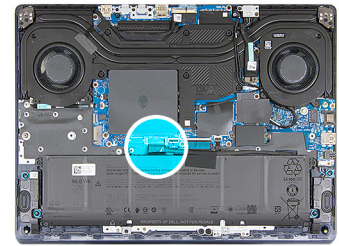

Figure 17. Connecting the battery cable



2x
M2x8



8x
M2x6

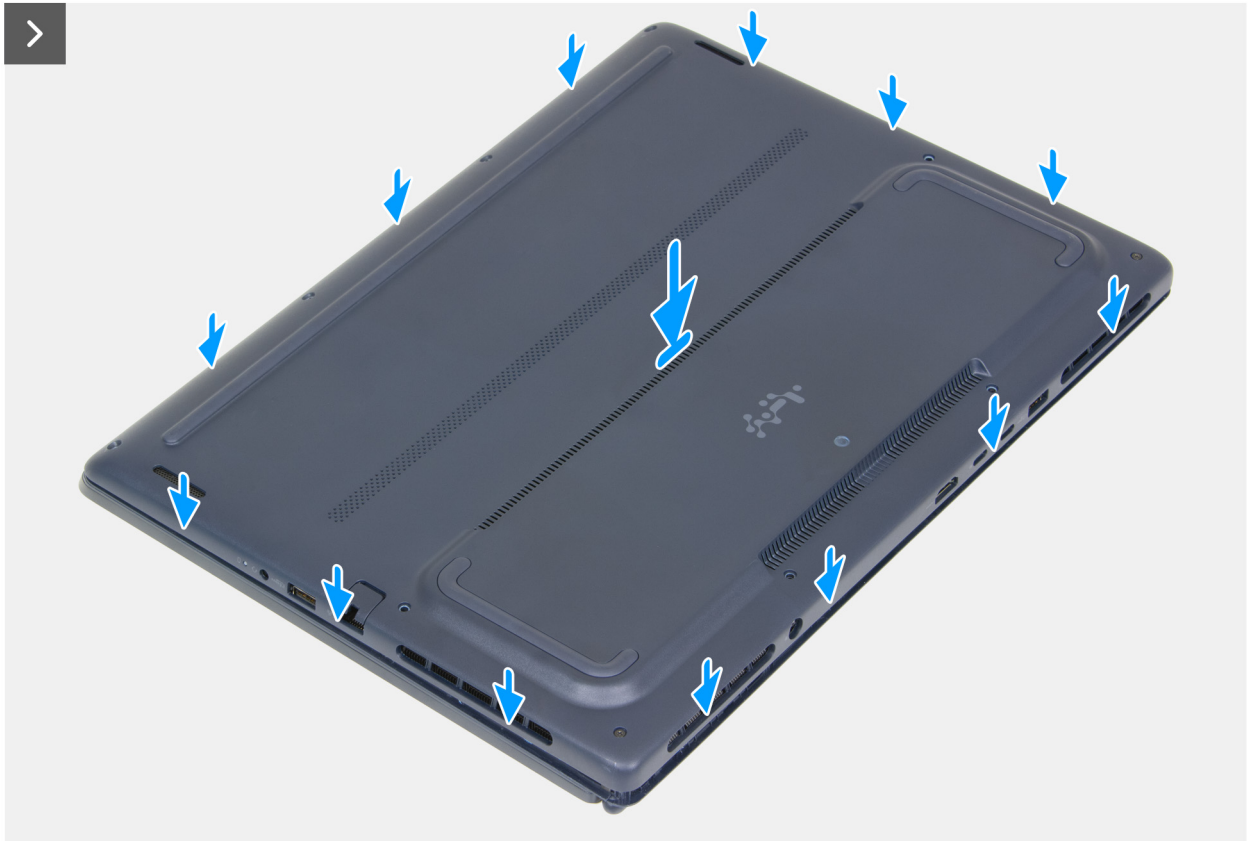

Figure 18. Installing the base cover



Figure 19. Installing the base cover

NOTE: If you have disconnected the battery cable, ensure to connect the battery cable. To connect the battery cable, follow step 1 in the procedure.

Steps

1. Connect the battery cable to the battery-cable connector (BATT1) on the system board.
2. Slide down the switch on the battery connector to restore power from the battery, if applicable.
NOTE: Ensure that the switch on the battery connector is at the **ON** position before installing the base cover.
3. Adhere the tape on the battery cable to the battery.
4. Align the screw holes on the base cover with the screw holes on the palm rest and keyboard assembly, and then snap the base cover into place.
5. Tighten the two captive screws (M2x8) that secure the base cover to the palm rest and keyboard assembly.
6. Replace the eight screws (M2x6) that secure the base cover to the palm rest and keyboard assembly.

Next steps

1. Follow the procedure in [After working inside your computer](#).

Battery

Rechargeable Li-ion battery precautions

- WARNING:**
- Exercise caution when handling rechargeable Li-ion batteries.

- Discharge the battery completely before removing it. Disconnect the AC power adapter from the computer and operate the computer solely on battery power—the battery is fully discharged when the computer no longer turns on when the power button is pressed.
- Do not crush, drop, mutilate, or penetrate the battery with foreign objects.
- Do not expose the battery to high temperatures, or disassemble battery packs and cells.
- Do not apply pressure to the surface of the battery.
- Do not bend the battery.
- Do not use tools of any kind to pry on or against the battery.
- To prevent accidental puncture or damage to the battery and other components, ensure that no screws are lost or misplaced during the servicing of the computer.
- Always purchase genuine batteries from [Dell Site](#) or authorized Dell partners and resellers.
- Swollen batteries should not be used and should be replaced and disposed properly. For guidelines on how to handle and replace swollen rechargeable Li-ion batteries, see [Handling swollen rechargeable Li-ion batteries](#).

Removing the 3-cell battery

Prerequisites

1. Follow the procedure in [Before working inside your computer](#).
2. Remove the [base cover](#).

About this task

 **CAUTION:** Removing the battery resets the BIOS setup settings to default. It is recommended that you note the BIOS setup settings before removing the battery.

The following images indicate the location of the 3-cell battery and provide a visual representation of the removal procedure.

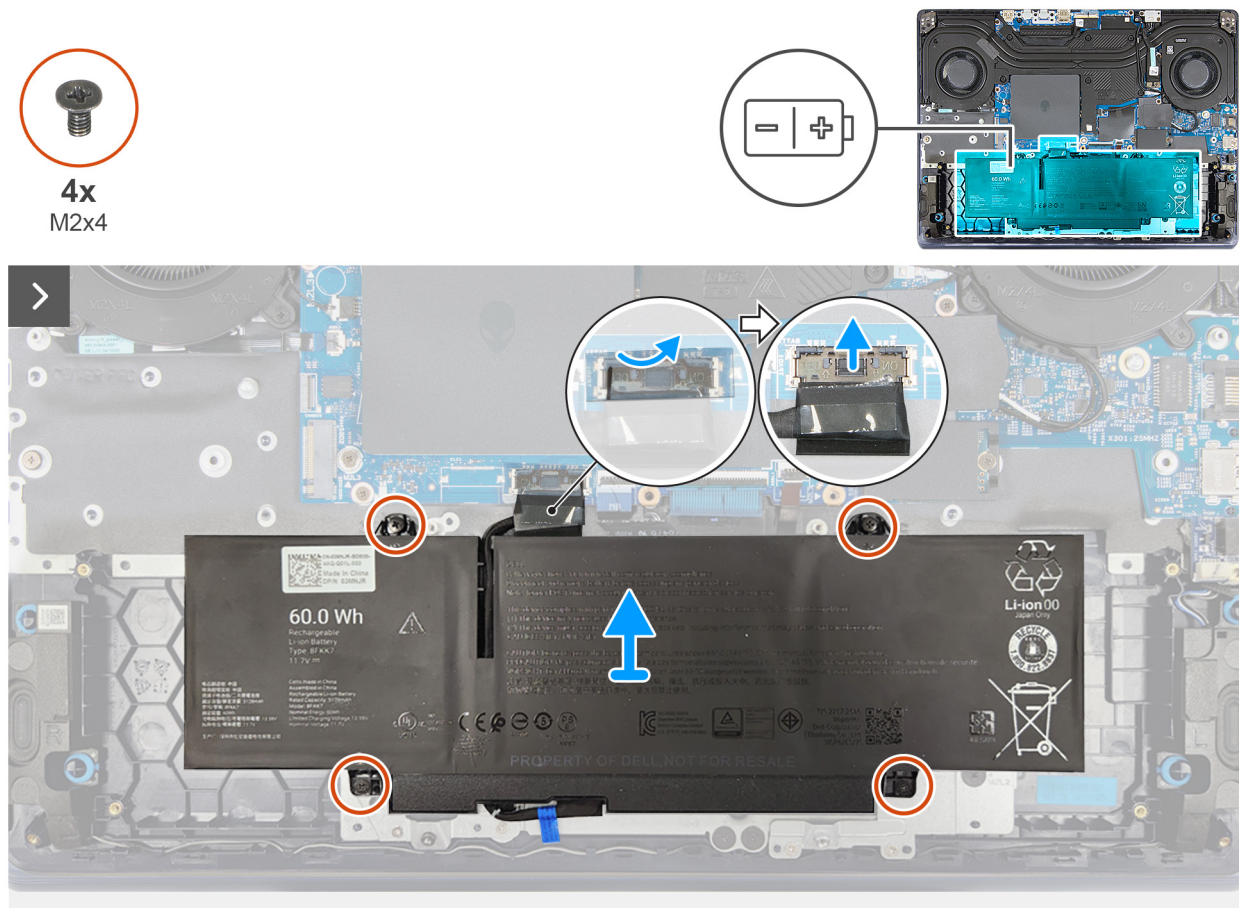

Figure 20. Removing the 3-cell battery

Steps

1. Disconnect the battery cable from the battery cable connector (BATT1) on the system board, if it has not been disconnected earlier.
2. Remove the four screws (M2x4) that secure the battery to the palm rest and keyboard assembly.
3. Lift the battery off the palm rest and keyboard assembly.

Installing the 3-cell battery

Prerequisites

If you are replacing a component, remove the existing component before performing the installation procedure.

About this task

The following images indicate the location of the 3-cell battery and provide a visual representation of the installation procedure.

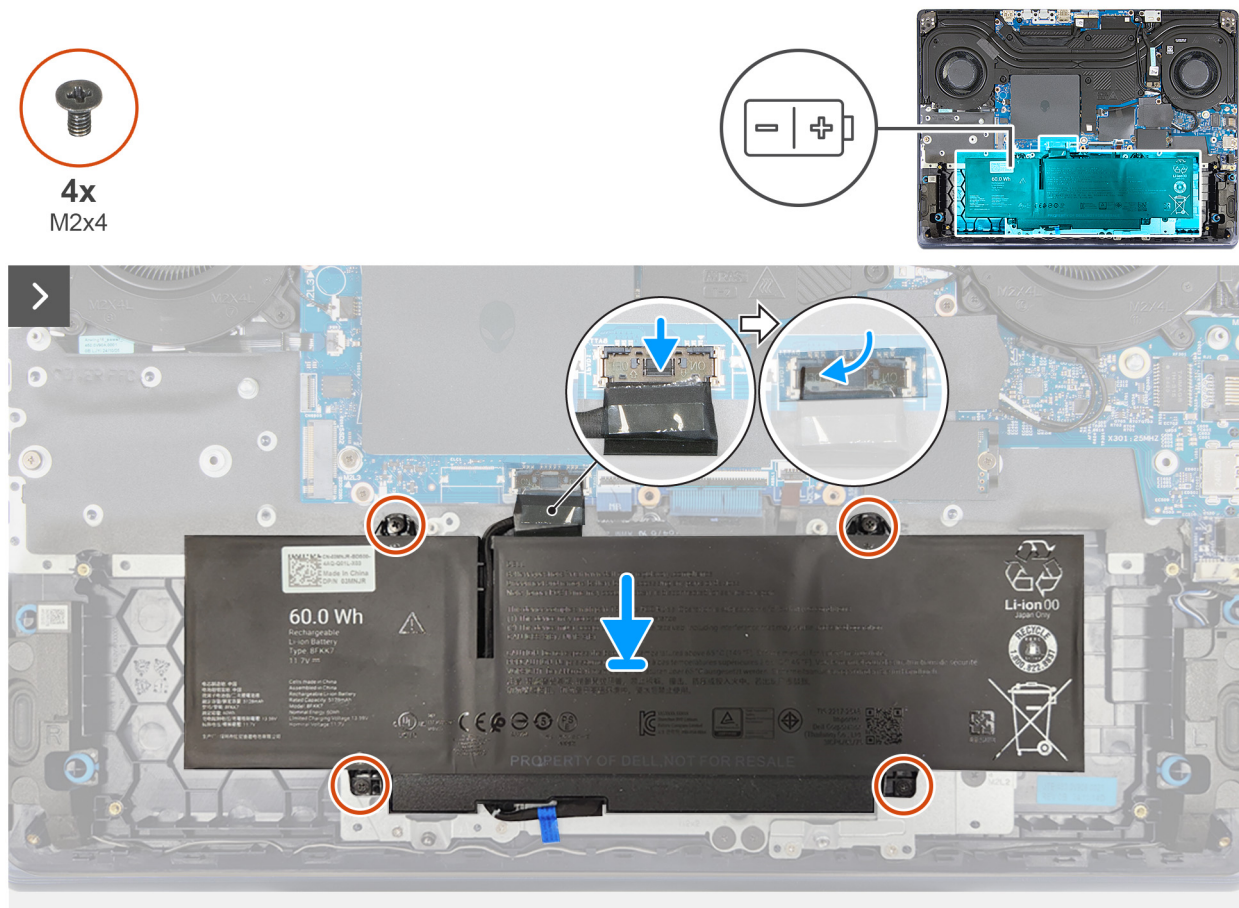

Figure 21. Installing the 3-cell battery

Steps

1. Align the screw holes on the battery with the screw holes on the palm rest and keyboard assembly.
2. Replace the four screws (M2x4) that secure the battery to the palm rest and keyboard assembly.
3. Connect the battery cable to the battery cable connector (BATT1) on the system board.

Next steps

1. Install the [base cover](#).
2. Follow the procedure in [After working inside your computer](#).

Removing the 6-cell battery

Prerequisites

1. Follow the procedure in [Before working inside your computer](#).
2. Remove the [base cover](#).

About this task

CAUTION: Removing the battery resets the BIOS setup settings to default. It is recommended that you note the BIOS setup settings before removing the battery.

The following images indicate the location of the 6-cell battery and provide a visual representation of the removal procedure.

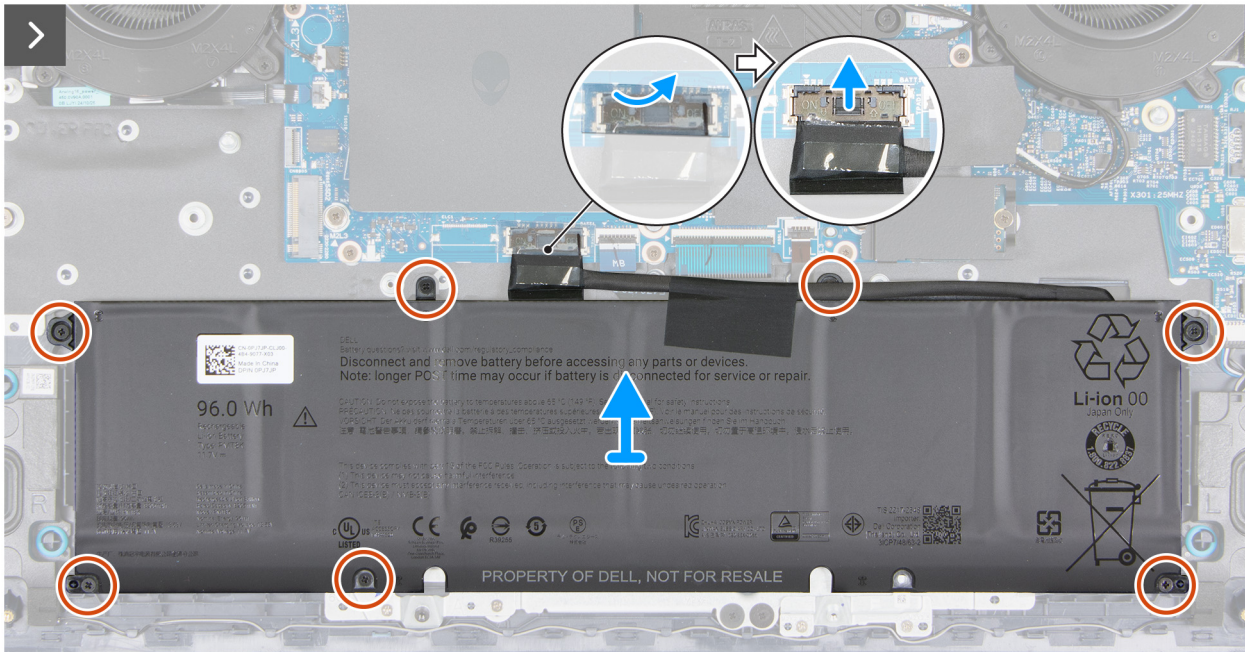
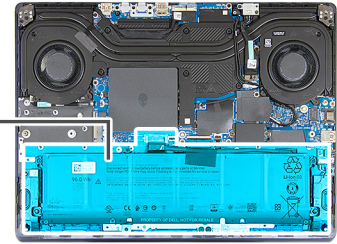
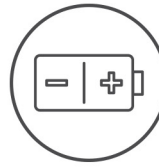

Figure 22. Removing the 6-cell battery

Steps

1. Peel off the tape to access the battery cable connector (BATT1).
2. Disconnect the battery cable from the battery cable connector (BATT1) on the system board, if it has not been disconnected earlier.
3. Remove the seven screws (M2x4) that secure the battery to the palm rest and keyboard assembly.
4. Lift the battery off the palm rest and keyboard assembly.

Installing the 6-cell battery

Prerequisites

If you are replacing a component, remove the existing component before performing the installation procedure.

About this task

The following images indicate the location of the battery and provide a visual representation of the installation procedure.



7x
M2x4

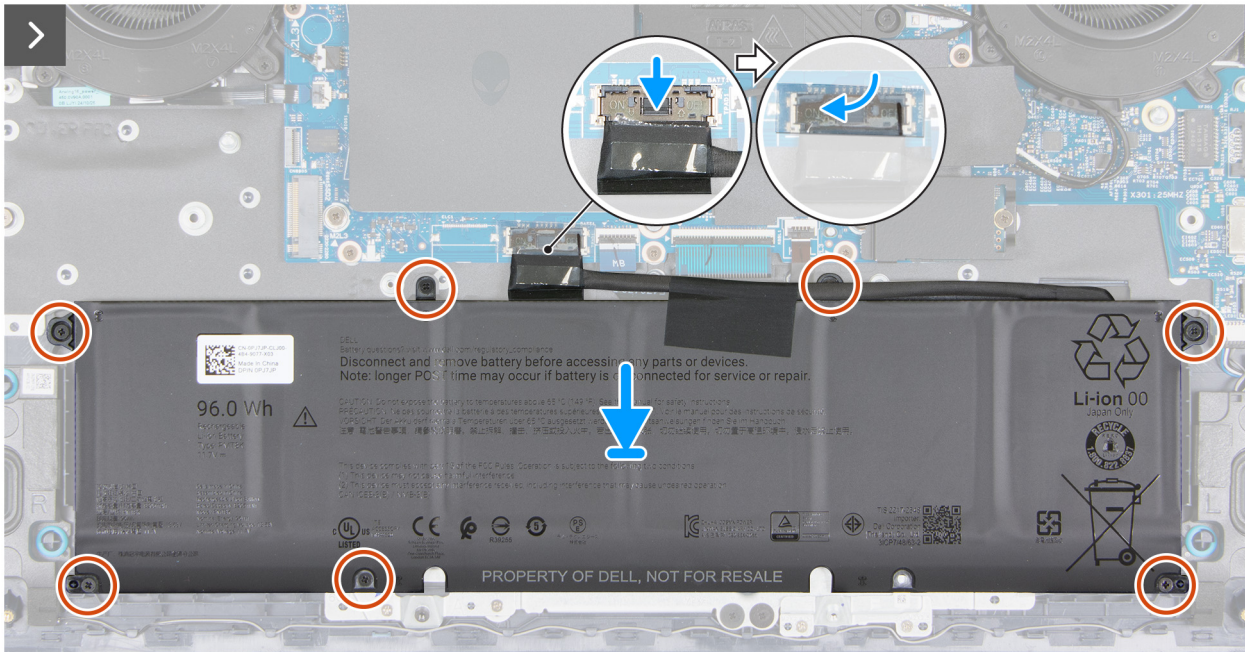
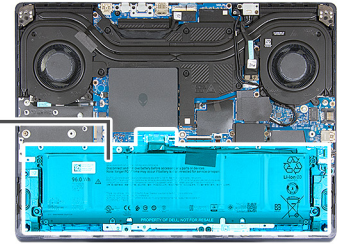
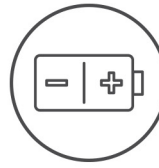

Figure 23. Installing the 6-cell battery

Steps

1. Using the alignment posts, place the battery on the palm rest and keyboard assembly.
2. Align the screw holes on the battery with the screw holes on the palm rest and keyboard assembly.
3. Replace the seven screws (M2x4) that secure the battery to the palm rest and keyboard assembly.
4. Connect the battery cable to the battery cable connector (BATT1) on the system board.
5. Adhere the tape on the battery cable to the battery.

Next steps

1. Install the [base cover](#).
2. Follow the procedure in [After working inside your computer](#).

Battery cable

Removing the 3-cell battery cable

Prerequisites

1. Follow the procedure in [Before working inside your computer](#).
2. Remove the [base cover](#).
3. Remove the [battery](#).

About this task

The following images indicate the location of the 3-cell battery cable and provide a visual representation of the removal procedure.

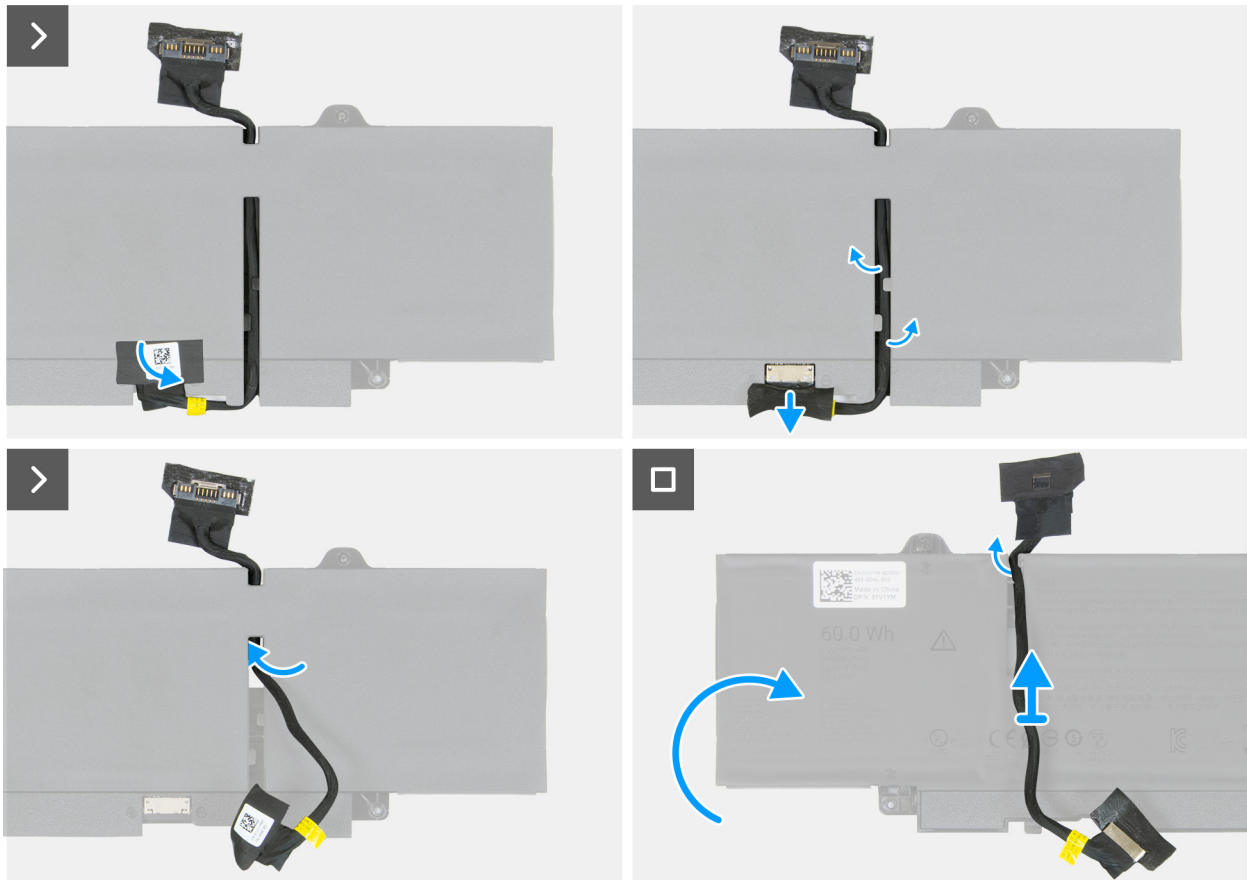

Figure 24. Removing the 3-cell battery cable

Steps

1. Remove the battery cable from the routing guides.
2. Turn the battery over and peel the tape to access the connector on the battery.
3. Disconnect the battery cable from the battery.
4. Remove the battery cable from the routing guides.
5. Slide the battery cable through the opening on the bottom side of the battery.

Installing the 3-cell battery cable

Prerequisites

If you are replacing a component, remove the existing component before performing the installation procedure.

About this task

The following images indicate the location of the 3-cell battery cable and provide a visual representation of the installation procedure.

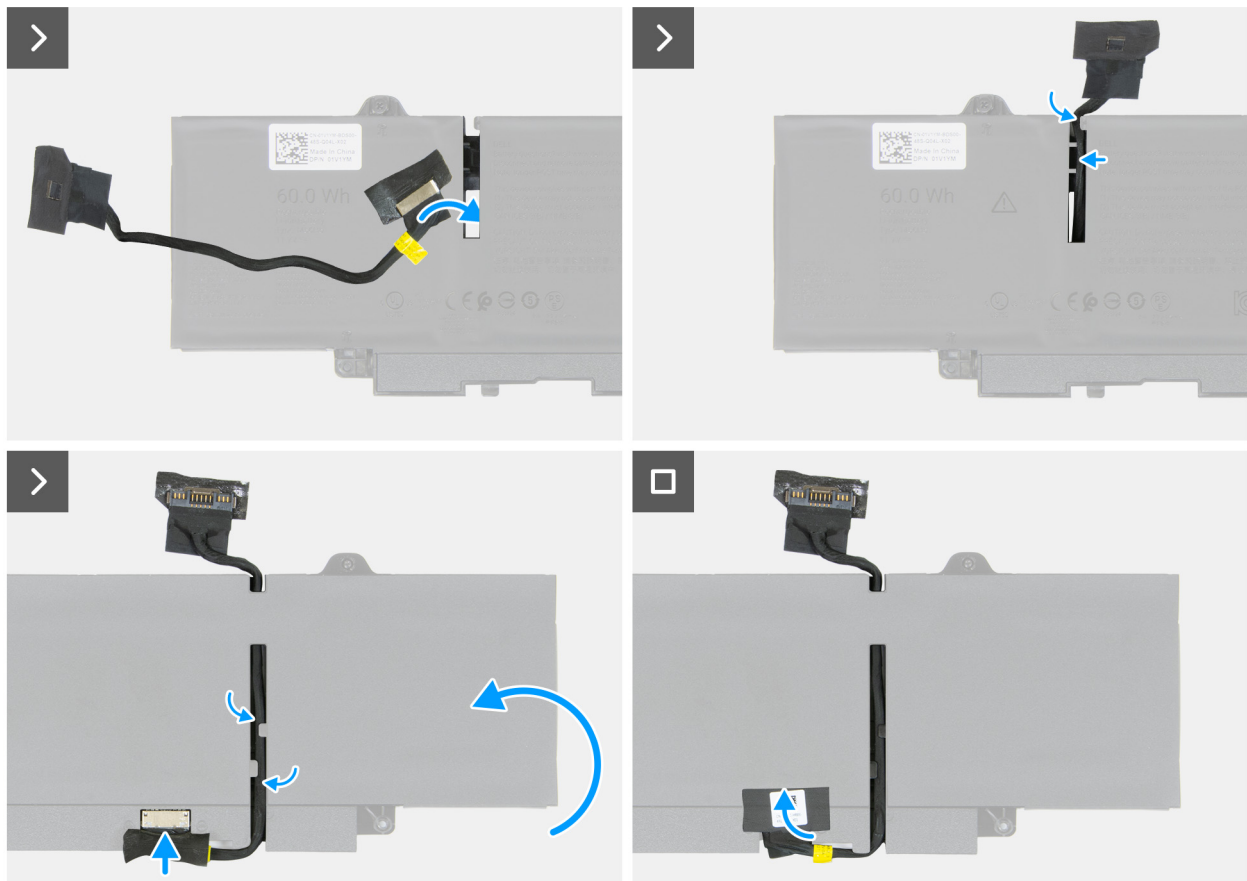

Figure 25. Installing the 3-cell battery cable

Steps

1. Insert the end of the battery cable (with the cable label) through the opening on the top side of the battery.
2. Route the battery cable through the routing guides on the battery.
3. Turn the battery over and route the battery cable through the routing guides on the bottom side of the battery.
4. Connect the battery cable to the connector on the battery.
5. Adhere the tape that secures the battery cable connector to the battery.

Next steps

1. Install the [battery](#).
2. Install the [base cover](#).
3. Follow the procedure in [After working inside your computer](#).

Removing the 6-cell battery cable

CAUTION: The information in this removal section is intended for authorized service technicians only.

Prerequisites

1. Follow the procedure in [Before working inside your computer](#).
2. Remove the [base cover](#).
3. Remove the [battery](#).

About this task

The following images indicate the location of the cable and provide a visual representation of the removal procedure.

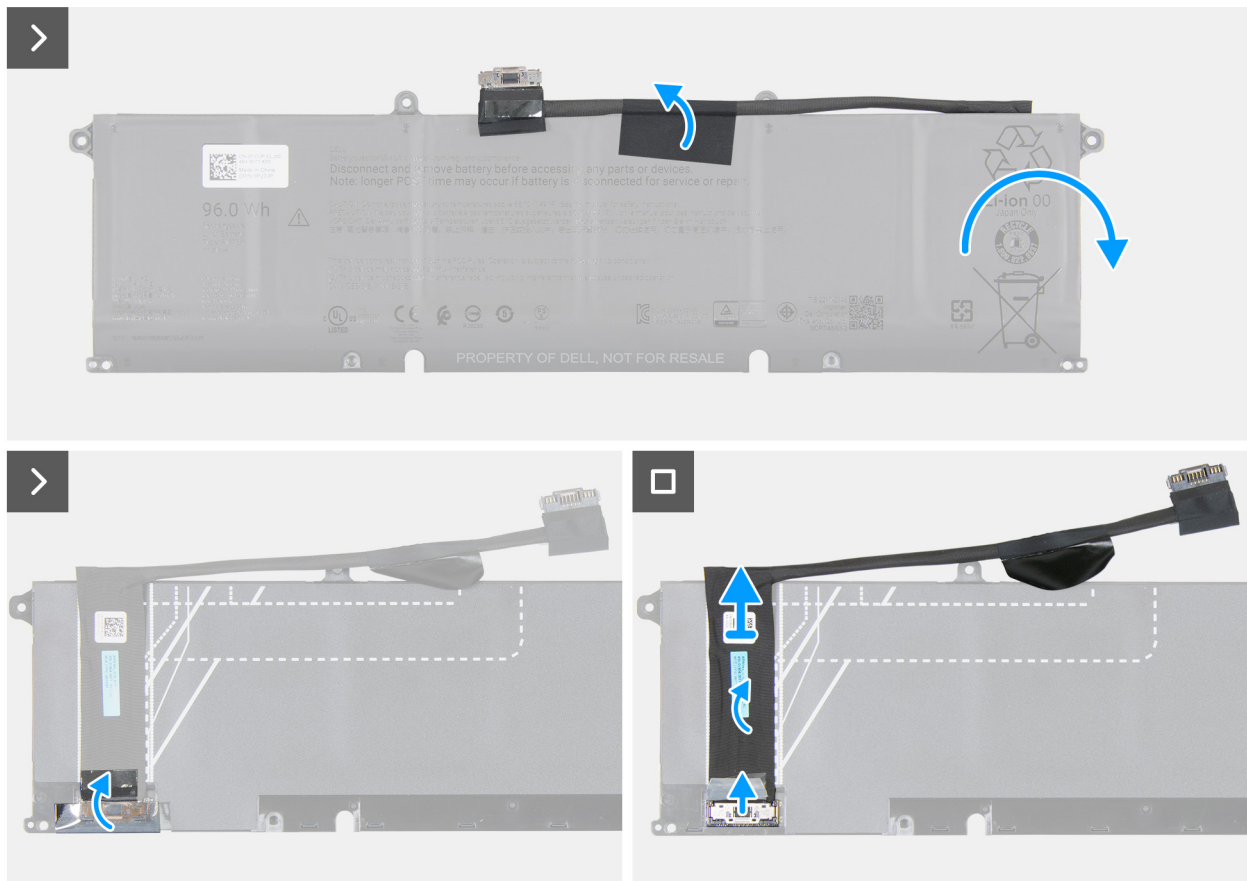

Figure 26. Removing the 6-cell battery cable

Steps

1. Peel the tape that adheres the battery cable to the battery.
2. Turn the battery over and peel the tape to access the connector on the battery.
3. Disconnect the battery cable from the battery.
4. Peel the battery cable off the battery.

Installing the 6-cell battery cable

CAUTION: The information in this installation section is intended for authorized service technicians only.

Prerequisites

If you are replacing a component, remove the existing component before performing the installation procedure.

About this task

The following images indicate the location of the 6-cell battery cable and provide a visual representation of the installation procedure.

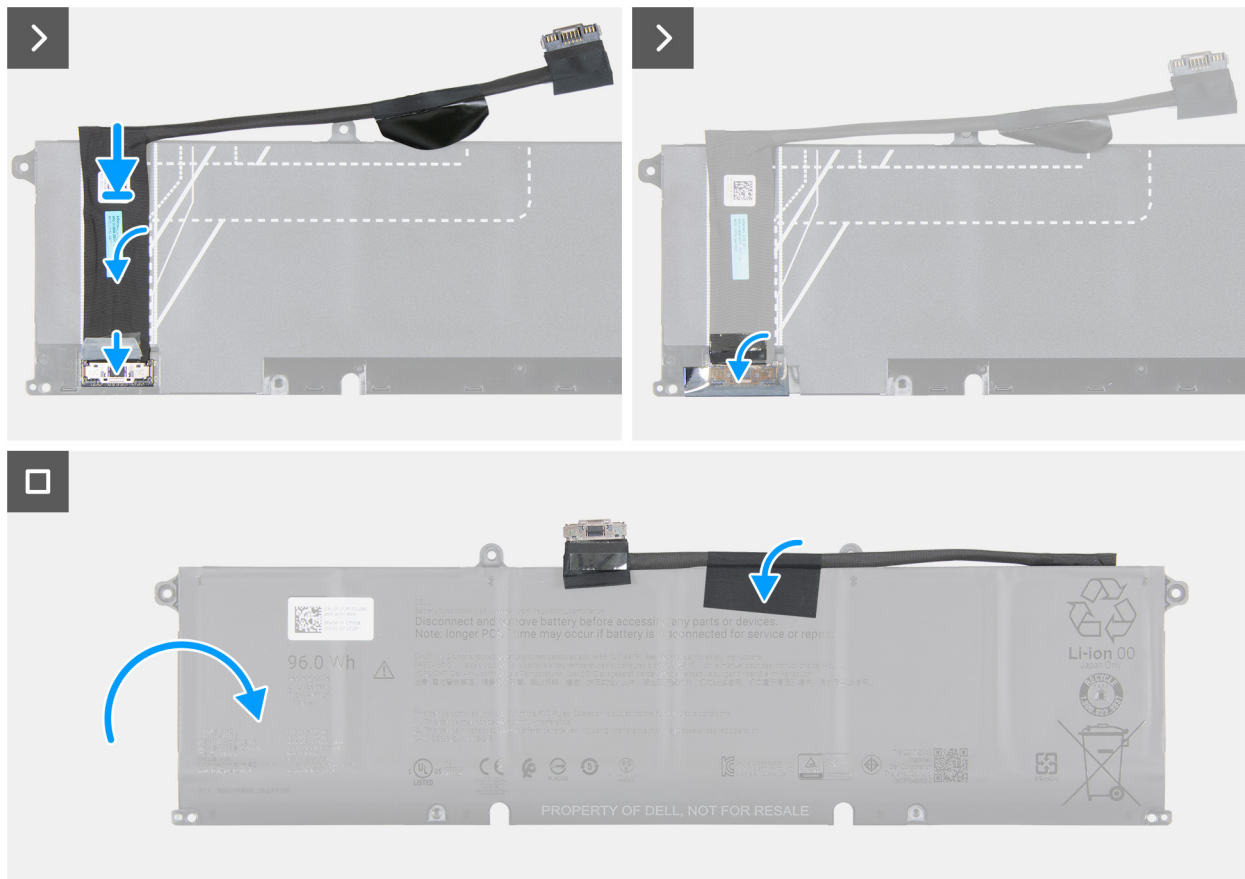

Figure 27. Installing the 6-cell battery cable

Steps

1. Connect the battery cable to the connector on the battery.
2. Adhere the battery cable along the guidelines on the battery.
3. Adhere the tape that secures the battery-cable connector to the battery.
4. Turn the battery over and adhere the tape that secures the battery cable to the battery.

Next steps

1. Install the [battery](#).
2. Install the [base cover](#).
3. Follow the procedure in [After working inside your computer](#).

Memory module

Removing the memory module

Prerequisites

1. Follow the procedure in [Before working inside your computer](#).
2. Remove the [base cover](#).

About this task

The following images indicate the location of the memory module and provide a visual representation of the removal procedure.

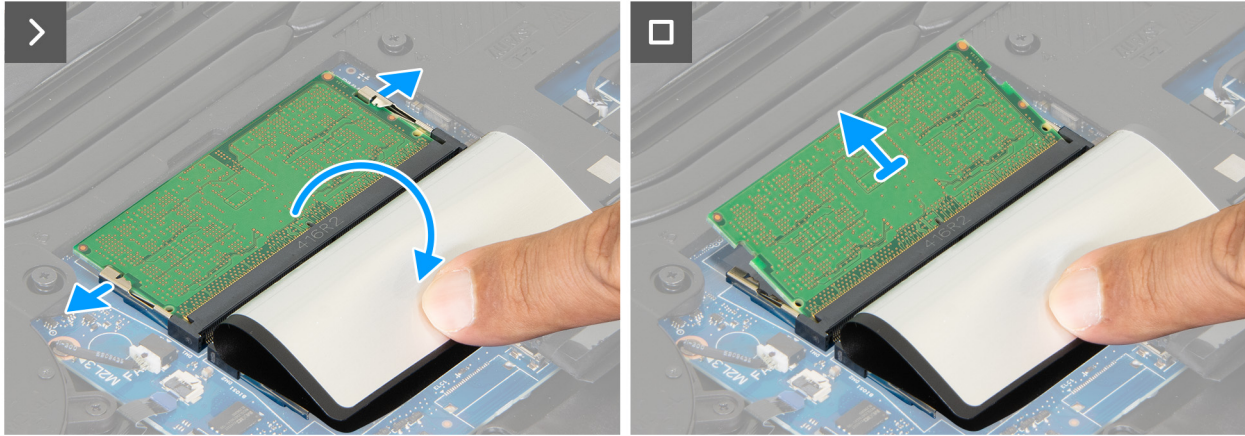
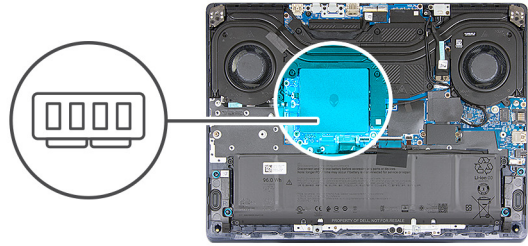

Figure 28. Removing the memory module

Steps

1. Lift the Mylar to access the memory.
2. Using your fingertips, spread apart the securing clips on the memory-module slot (DIMM1 or DIMM2) until the memory module pops up.

CAUTION: To prevent damage to the memory module, hold the memory module by the edges. Do not touch the components or metallic contacts on the memory module as electrostatic discharge (ESD) can inflict severe damage on the components. To read more about ESD protection, see [ESD protection](#).

3. Slide and remove the memory module from the memory-module slot (DIMM1 or DIMM2) on the system board.

NOTE: Repeat step 1 and step 2 if there is more than one memory module installed on your computer.

Installing the memory module

Prerequisites

If you are replacing a component, remove the existing component before performing the installation process.

About this task

The following images indicate the location of the memory module and provide a visual representation of the installation procedure.

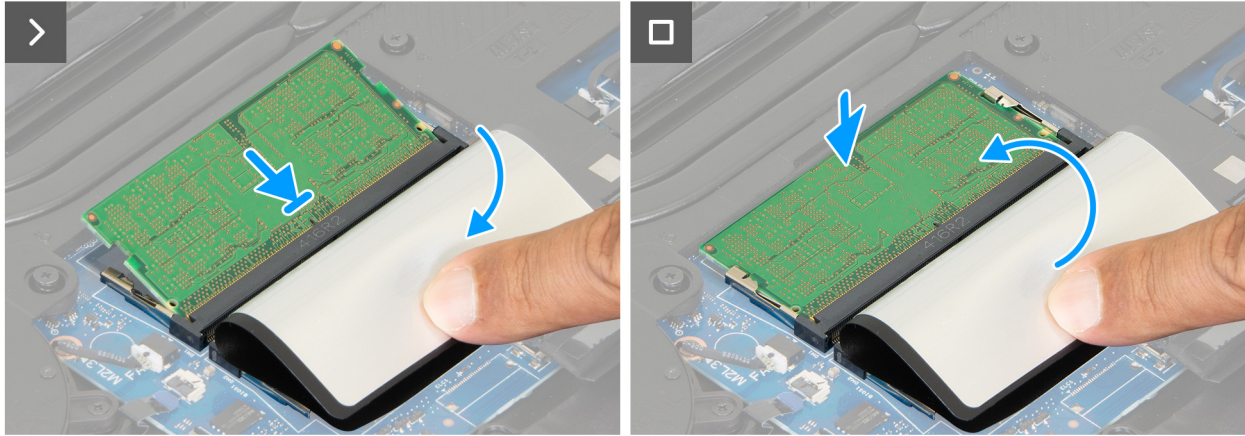
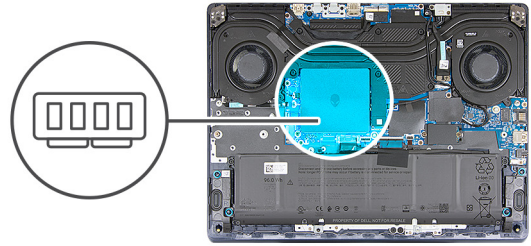

Figure 29. Installing the memory module

Steps

1. Lift the Mylar to access the memory-module slot.
2. Align the notch on the memory module with the tab on the memory-module slot (DIMM1 or DIMM2).

CAUTION: To prevent damage to the memory module, hold the memory module by the edges. Do not touch the components or metallic contacts on the memory module as electrostatic discharge (ESD) can inflict severe damage on the components. To read more about ESD protection, see [ESD protection](#).

3. Slide the memory module firmly into the slot (DIMM1 or DIMM2) at an angle.
4. Press the memory module down until it clicks into place.

NOTE: The securing clips return to a locked position. If you do not hear the click, remove the memory module and reinstall it.

5. Replace the Mylar to cover the memory-module slots (DIMM1 and DIMM2).

Next steps

1. Install the [base cover](#).
2. Follow the procedure in [After working inside your computer](#).

Solid-state drive

Removing the M.2 2230 SSD in the SSD1 slot

Prerequisites

1. Follow the procedure in [Before working inside your computer](#).
2. Remove the [base cover](#).

About this task

The following images indicate the location of the M.2 2230 SSD in the SSD1 slot and provide a visual representation of the removal procedure.

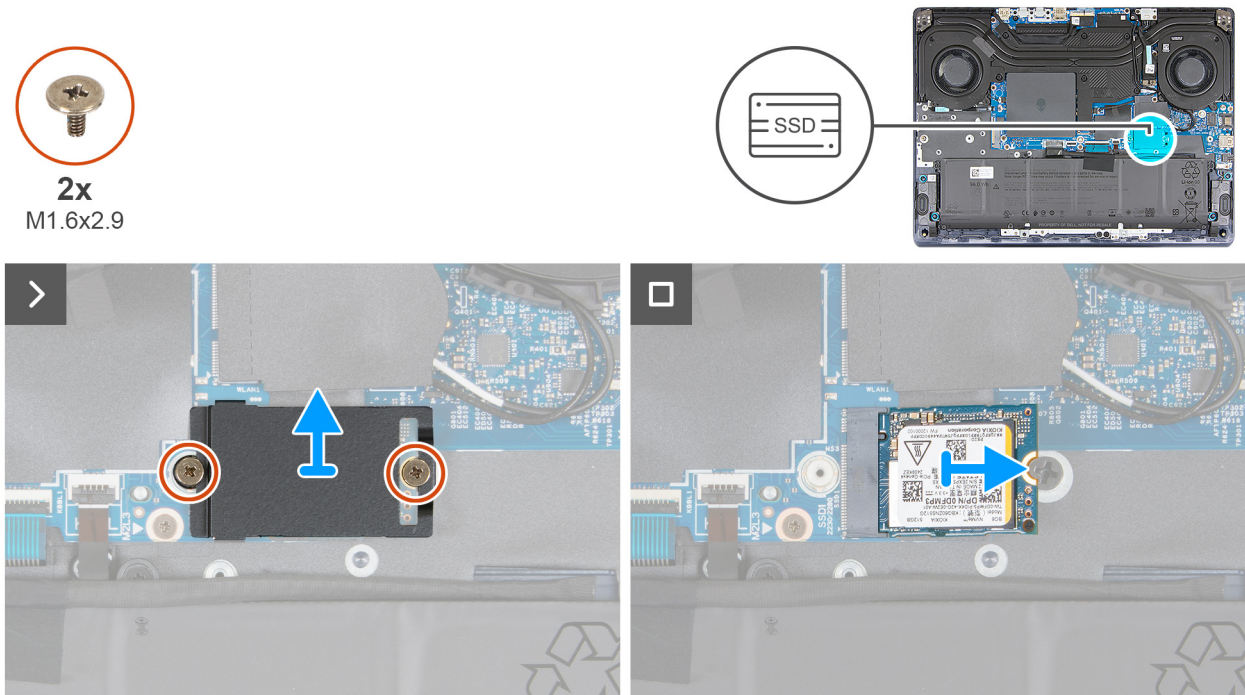

Figure 30. Removing the M.2 2230 SSD in the SSD1 slot

Steps

1. Remove the screw (M1.6x2.9) that secures the SSD thermal shield to the system board.
2. Remove the screw (M1.6x2.9) that secures the SSD thermal shield to the SSD screw mount.
3. Lift the SSD thermal shield off the SSD.
4. Slide and lift the SSD from its slot (SSD1).

Installing the M.2 2230 SSD in the SSD1 slot

Prerequisites

If you are replacing a component, remove the existing component before performing the installation process.

About this task

The following images indicate the location of M.2 2230 SSD in the SSD1 slot and provide a visual representation of the installation procedure.

NOTE: A thermal shield (with thermal pad) must be installed over the SSD as described in the SSD replacement instructions. If required, a new thermal shield (with thermal pad) can be purchased separately from Dell.

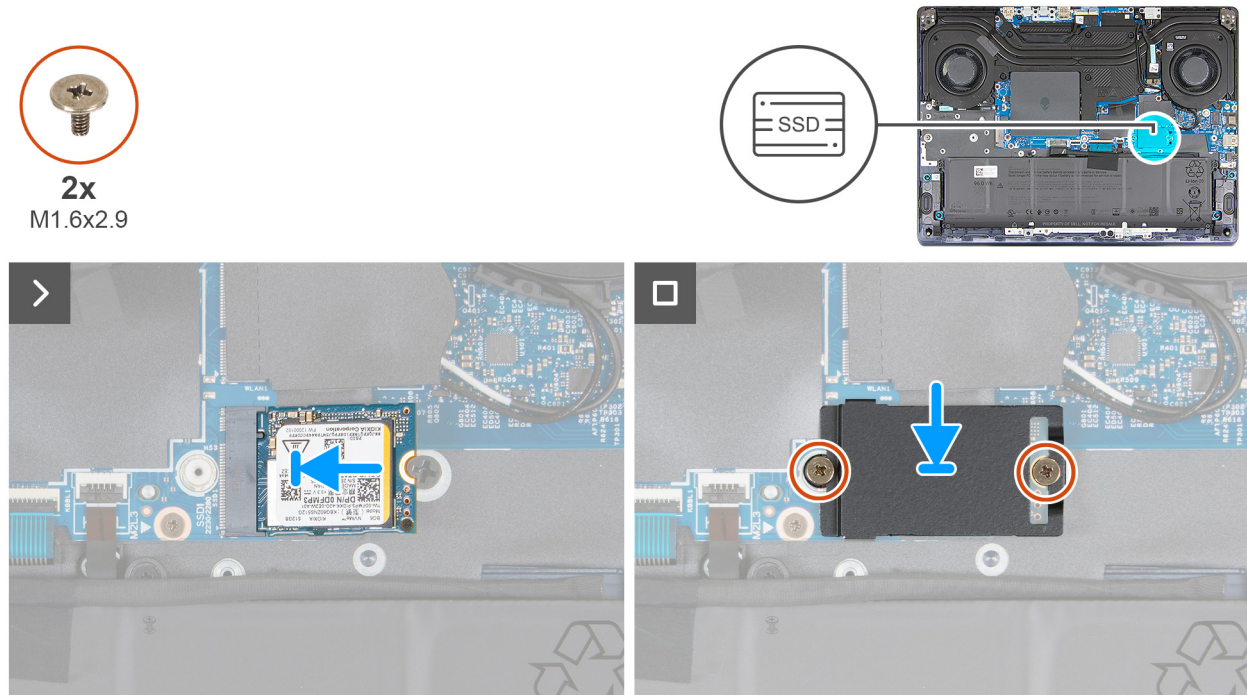

Figure 31. Installing the M.2 2230 SSD in the SSD1 slot

Steps

1. Align the notch on the SSD with the tab on the SSD slot (SSD1) on the system board.
2. Slide the SSD into its slot (SSD1) on the system board.
3. Slide the tab on the SSD thermal shield into the SSD slot.
4. Align the screw holes on the SSD thermal shield with the screw holes on the system board and SSD screw mount.

NOTE: If using a new SSD thermal shield, peel the cover off the thermal pad before use.

5. Replace the screw (M1.6x2.9) that secures the SSD thermal shield to the system board.
6. Replace the screw (M1.6x2.9) that secures the SSD thermal shield to the SSD screw mount.

Next steps

1. Install the [base cover](#).
2. Follow the procedure in [After working inside your computer](#).

Removing the M.2 2230 SSD in the SSD2 slot

Prerequisites

1. Follow the procedure in [Before working inside your computer](#).
2. Remove the [base cover](#).

About this task

The following images indicate the location of the M.2 2230 SSD in the SSD2 slot and provide a visual representation of the removal procedure.

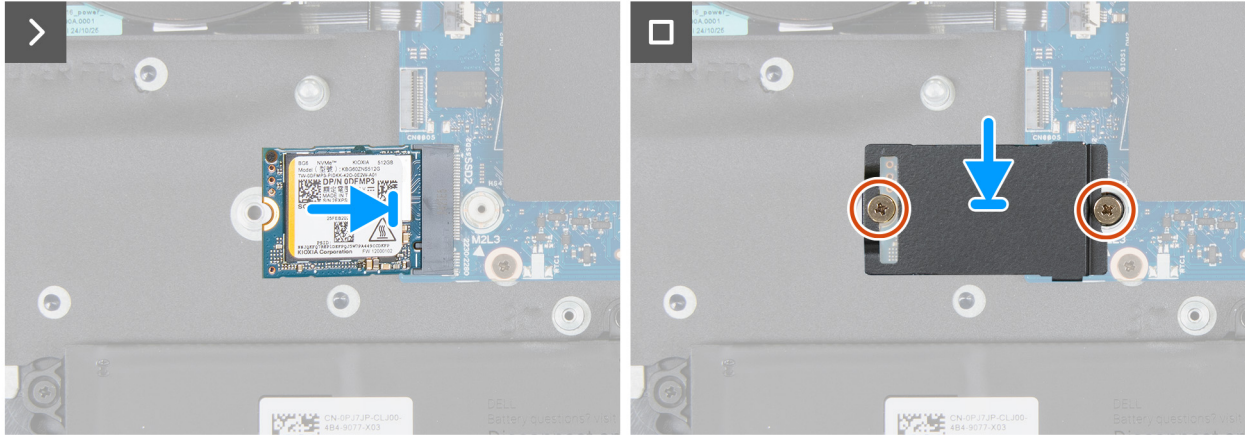
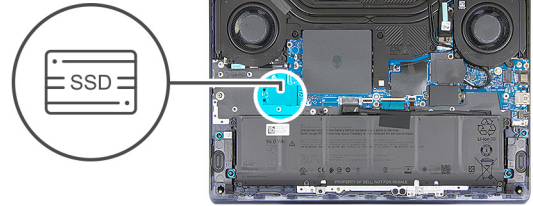

Figure 32. Removing the M.2 2230 SSD in the SSD2 slot

Steps

1. Remove the screw (M1.6x2.9) that secures the SSD thermal shield to the system board.
2. Remove the screws (M1.6x2.9) that secures the SSD thermal shield to the palm rest and keyboard assembly.
3. Lift the SSD thermal shield off the SSD.
4. Slide and lift the SSD from its slot (SSD2).

Installing the M.2 2230 SSD in the SSD2 slot

Prerequisites

If you are replacing a component, remove the existing component before performing the installation process.

About this task

The following images indicate the location of M.2 2230 SSD in the SSD2 slot and provide a visual representation of the installation procedure.

i **NOTE:** A thermal shield (with thermal pad) must be installed over the SSD as described in the SSD replacement instructions. If required, a new thermal shield (with thermal pad) can be purchased separately from Dell.

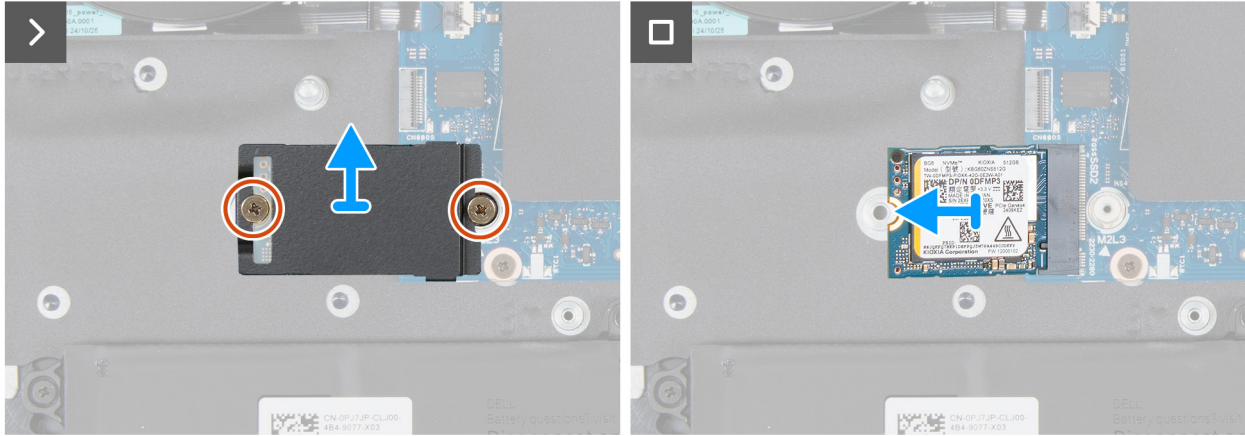
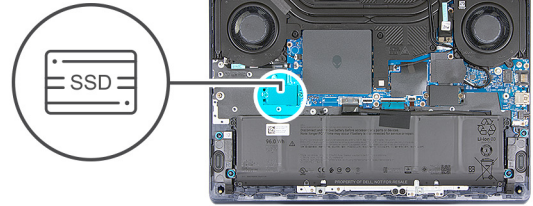

Figure 33. Installing the M.2 2230 SSD in the SSD2 slot

Steps

1. Align the notch on the SSD with the tab on the SSD slot (SSD2) on the system board.
2. Slide the SSD into its slot (SSD2) on the system board.
3. Slide the tab on the SSD thermal shield into the SSD slot.
4. Align the screw holes on the SSD thermal shield with the screw holes on the system board and palm rest and keyboard assembly.

NOTE: If using a new SSD thermal shield, peel the cover off the thermal pad before use.

5. Replace the screw (M1.6x2.9) that secures the SSD thermal shield to the system board.
6. Replace the screw (M1.6x2.9) that secures the SSD thermal shield to the palm rest and keyboard assembly.

Next steps

1. Install the [base cover](#).
2. Follow the procedure in [After working inside your computer](#).

Wireless card

Removing the wireless card

Prerequisites

1. Follow the procedure in [Before working inside your computer](#).
2. Remove the [base cover](#).

About this task

The following images indicate the location of the wireless card and provide a visual representation of the removal procedure.



1x
M2x3

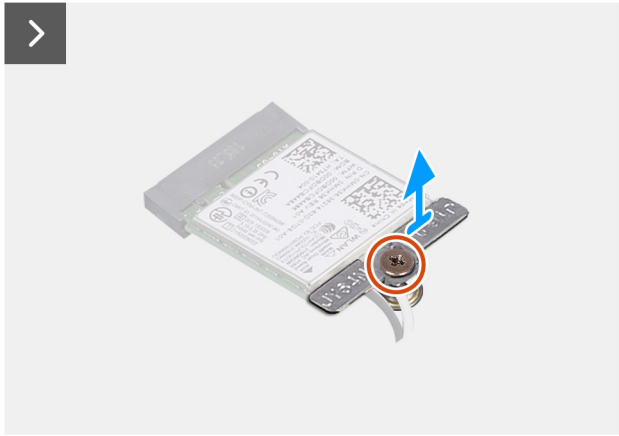
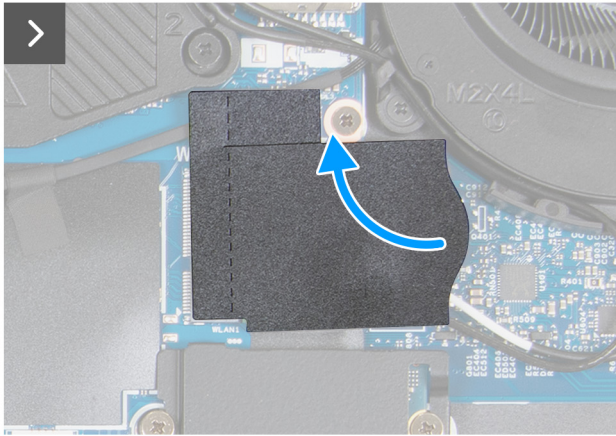
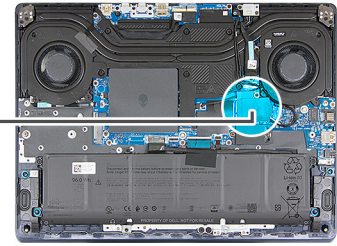

Figure 34. Removing the wireless card

Steps

1. Peel off the Mylar to access the wireless card.
2. Remove the screw (M2x3) that secures the wireless-card bracket to the wireless card and palm rest and keyboard assembly.
3. Lift the wireless-card bracket off the wireless card.
4. Disconnect the antenna cables from the wireless card.
5. Slide and remove the wireless card at an angle from the wireless-card slot (WLAN).

Installing the wireless card

Prerequisites

If you are replacing a component, remove the existing component before performing the installation process.

About this task

The following images indicate the location of the wireless card and provide a visual representation of the installation procedure.



1x
M2x3

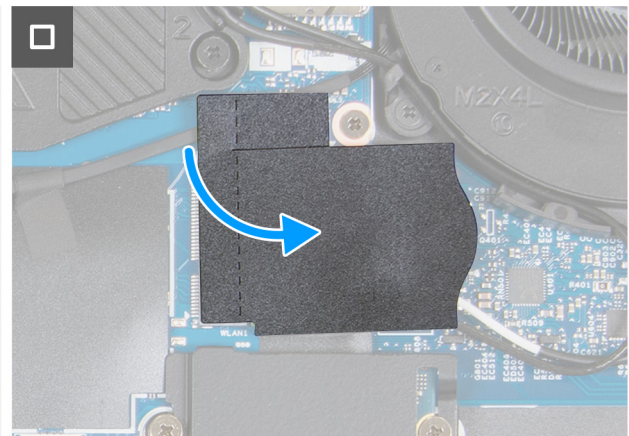
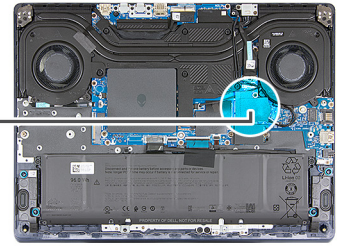

Figure 35. Installing the wireless card

Steps

1. Connect the antenna cables to the wireless card.

NOTE: The following table provides the antenna-cable color scheme for the wireless card that is supported on your computer.

Table 27. Antenna-cable color scheme

Connectors on the wireless card	Antenna-cable color	Label marking	
Main	White	MAIN 2	△ (white triangle)
Auxiliary	Black	AUX 1	▲ (black triangle)

2. Align the notch on the wireless card with the tab on the wireless-card slot (WLAN) and insert the wireless card at an angle into the slot.
3. Align the screw hole on the wireless-card bracket with the screw hole on the wireless card and palm rest and keyboard assembly.
4. Replace the screw (M2x3) that secures the wireless-card bracket to the wireless card and the palm rest and keyboard assembly.

5. Replace the Mylar that covers the wireless card.

Next steps

1. Install the [base cover](#).
2. Follow the procedure in [After working inside your computer](#).

Speakers

Removing the speakers

Prerequisites

1. Follow the procedure in [Before working inside your computer](#).
2. Remove the [base cover](#).

About this task

The following images indicate the location of the speakers and provide a visual representation of the removal procedure.

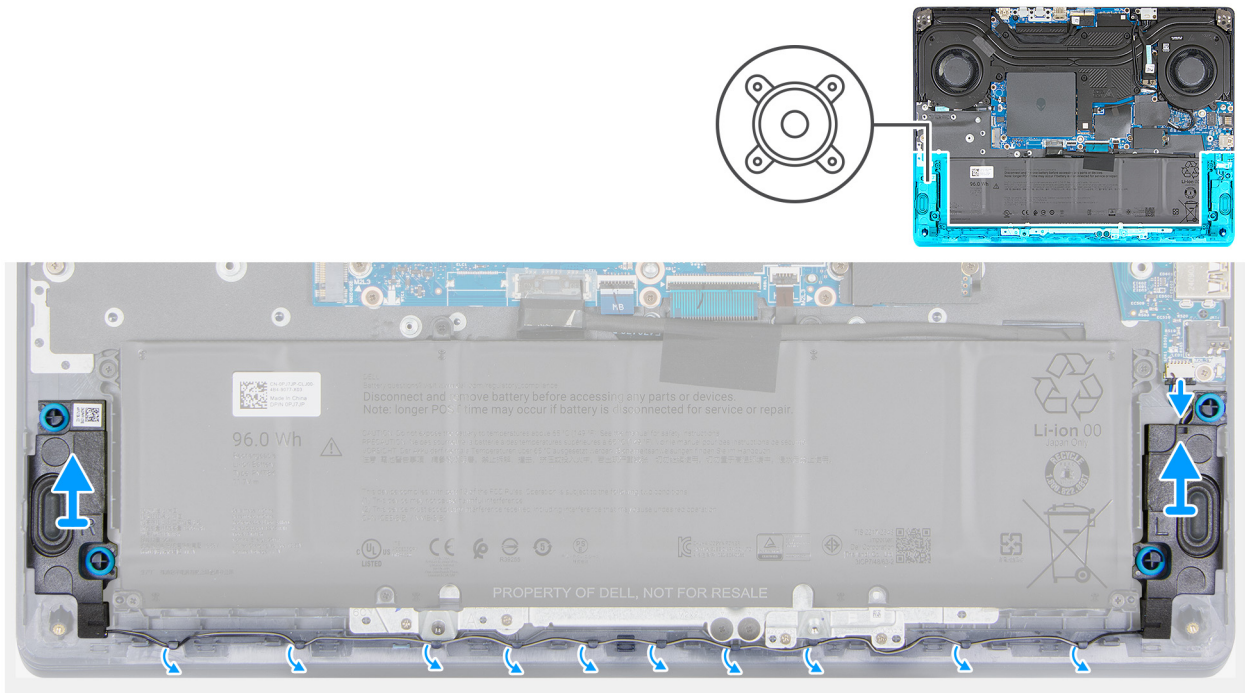

Figure 36. Removing the speakers

Steps

1. Disconnect the speaker cable from the connector (SPK1) on the I/O board.
2. Remove the speaker cable from the routing guides on the palm rest and keyboard assembly.
3. Lift the right and left speaker, along with its cable, off the palm rest and keyboard assembly.

Installing the speakers

Prerequisites

If you are replacing a component, remove the existing component before performing the installation process.

About this task

The following images indicate the location of the speakers and provide a visual representation of the installation procedure.

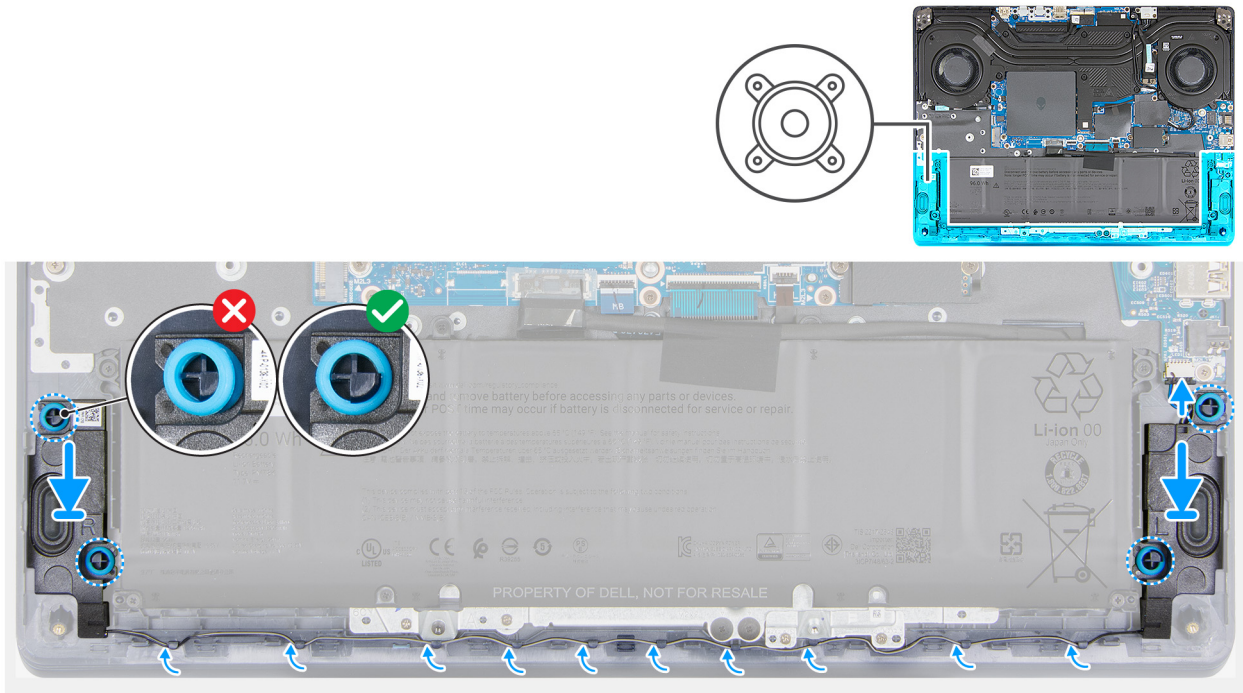

Figure 37. Installing the speakers

Steps

1. Using the alignment posts, place the left and right speakers into their slots on the palm rest and keyboard assembly.
NOTE: Ensure that the alignment posts are threaded completely through the rubber grommets on the speakers.
2. Route the speaker cable through the routing guides on the palm rest and keyboard assembly.
3. Connect the speaker cable to the connector (SPK1) on the I/O board.

Next steps

1. Install the [base cover](#).
2. Follow the procedure in [After working inside your computer](#).

Removing and installing Field Replaceable Units (FRUs)

The replaceable components in this chapter are Field Replaceable Units (FRUs).

 **CAUTION:** The information in this section is intended for authorized service technicians only.

 **CAUTION:** To avoid any potential damage to the component or loss of data, ensure that an authorized service technician replaces the Field Replaceable Units (FRUs).

 **CAUTION:** Dell Technologies recommends that these procedures be performed by trained technical repair specialists.

 **CAUTION:** Your warranty does not cover damages that may occur during FRU repairs that are not authorized by Dell Technologies.

 **NOTE:** The images in this document may differ from your computer depending on the configuration you ordered.

Power-adapter port

Removing the power-adapter port

 **CAUTION:** The information in this removal section is intended for authorized service technicians only.

Prerequisites

1. Follow the procedure in [Before working inside your computer](#).
2. Remove the [base cover](#).

About this task

The following images indicate the location of the power-adapter port and provide a visual representation of the removal procedure.



2x
M2x3

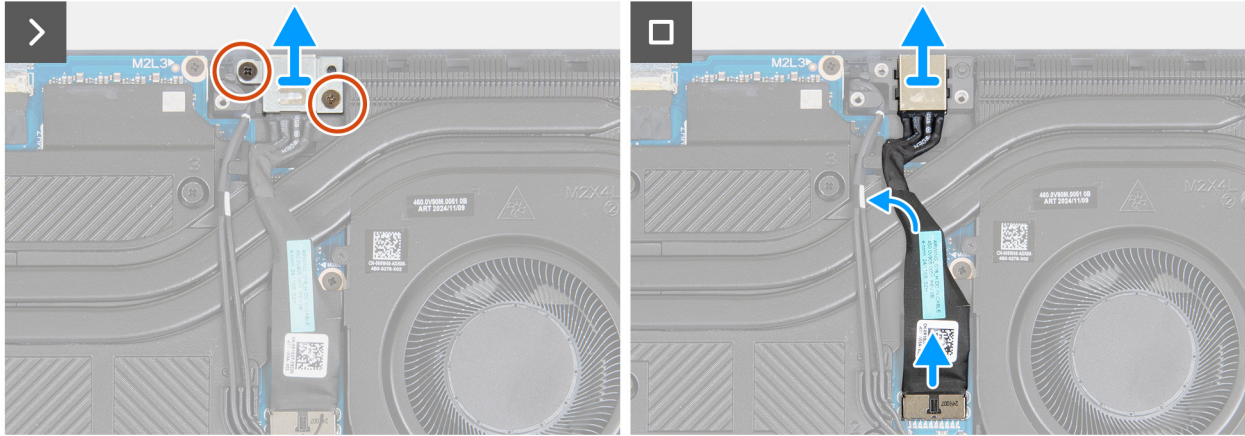
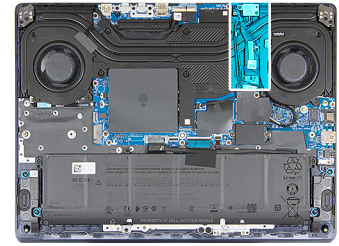

Figure 38. Removing the power-adapter port

Steps

1. Remove the two screws (M2x3) that secure the power-adapter port bracket to the palm rest and keyboard assembly.
2. Lift the power-adapter port bracket off the palm rest and keyboard assembly.
3. Disconnect the power-adapter port cable from the connector (DCIN) on the system board.
4. Lift the power-adapter port along with its cable from the palm rest and keyboard assembly.

Installing the power-adapter port

CAUTION: The information in this installation section is intended for authorized service technicians only.

Prerequisites

If you are replacing a component, remove the existing component before performing the installation process.

About this task

The following images indicate the location of the power-adapter port and provide a visual representation of the installation procedure.



2x
M2x3

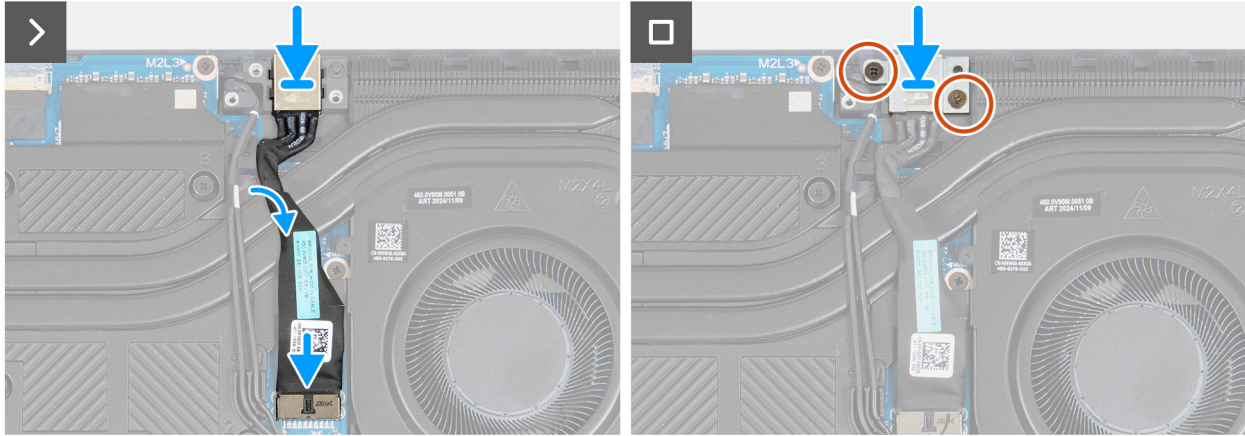
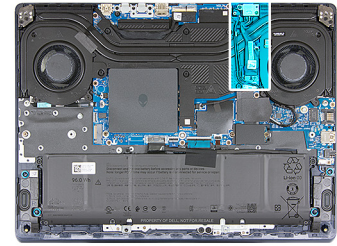

Figure 39. Installing the power-adapter port

Steps

1. Connect the power-adapter port cable to the connector (DCIN) on the system board.
2. Place the power-adapter port into the slot on the palm rest and keyboard assembly.
3. Align the screw holes on the power-adapter port bracket with the screw holes on the palm rest and keyboard assembly.
4. Replace the two screws (M2x3) that secure the power-adapter port bracket to the palm rest and keyboard assembly.

Next steps

1. Install the [base cover](#).
2. Follow the procedure in [After working inside your computer](#).

Fan and heat-sink assembly

Removing the fan and heat-sink assembly

CAUTION: The information in this removal section is intended for authorized service technicians only.

Prerequisites

1. Follow the procedure in [Before working inside your computer](#).
2. Remove the [base cover](#).
3. Remove the [wireless card](#).
4. Remove the [power-adapter port](#).

About this task

CAUTION: The heat sink may become hot during normal operation. Allow sufficient time for the heat sink to cool before you touch it.

NOTE: For maximum cooling of the processor, do not touch the heat-transfer areas on the heat sink. The oils in your skin can reduce the heat-transfer capability of the thermal grease.

The following images indicate the location of the fan and heat-sink assembly and provide a visual representation of the removal procedure.

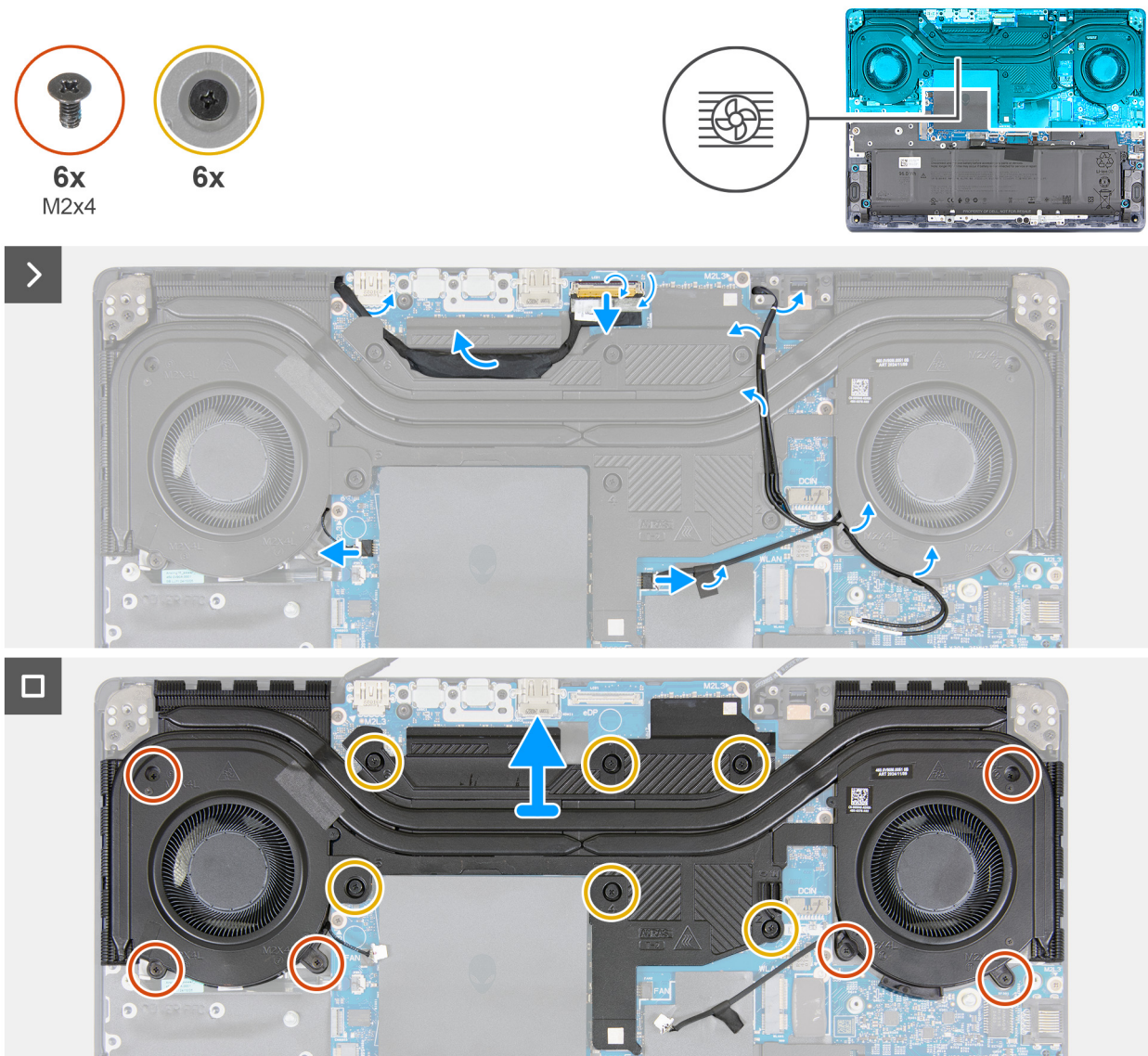

Figure 40. Removing the fan and heat-sink assembly

Steps

1. Open the latch and disconnect the display cable from the connector (LCD1) on the system board.
2. Remove the display cable from the routing guides on the fan and heat-sink assembly.
3. Remove the antenna cables from the routing guides on the fan and heat-sink assembly.
4. Disconnect the right fan cable from the connector (FAN1) on the system board.
5. Disconnect the left fan cable from the connector (FAN2) on the system board.
6. Remove the six screws (M2x4) that secure the fan and heat-sink assembly to the system board.
7. In reverse sequential order (12>11>10>9>8>7), remove the six screws (M2x4) that secure the fan and heat-sink assembly to the system board.
8. In reverse sequential order (6>5>4>3>2>1), loosen the six captive screws that secure the fan and heat-sink assembly to the system board.
9. Lift the fan and heat-sink assembly off the system board.

Installing the fan and heat-sink assembly

CAUTION: The information in this installation section is intended for authorized service technicians only.

Prerequisites

If you are replacing a component, remove the existing component before performing the installation process.

About this task

The following images indicate the location of the fan and heat-sink assembly and provide a visual representation of the installation procedure.

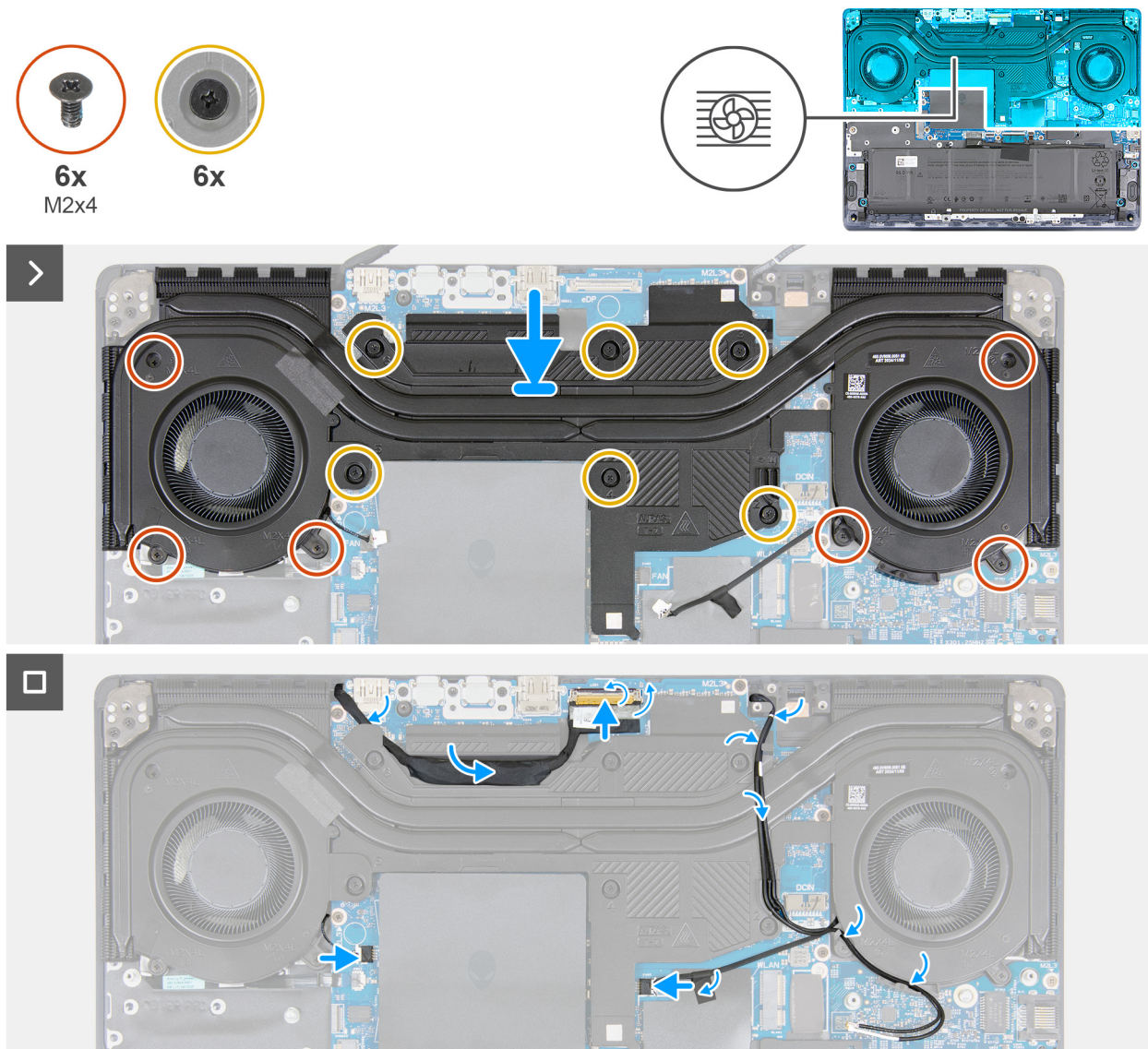

Figure 41. Installing the fan and heat-sink assembly

Steps

1. Align the screw holes on the fan and heat-sink assembly with the screw holes on the system board.
2. In sequential order (1>2>3>4>5>6), tighten the six captive screws that secure the fan and heat-sink assembly to the system board.
3. In sequential order (7>8>9>10>11>12), replace the six screws (M2x4) that secure the fan and heat-sink assembly to the system board.

4. Connect the left fan cable to the connector (FAN2) on the system board.
5. Connect the right fan cable to the connector (FAN1) on the system board.
6. Route the antenna cables through the routing guides on the fan and heat-sink assembly.
7. Route the display cable through the routing guides on the fan and heat-sink assembly.
8. Connect the display cable to the connector (LCD1) on the system board and close the latch to secure the cable.

Next steps

1. Install the [power-adaptor port](#).
2. Install the [wireless card](#).
3. Install the [base cover](#).
4. Follow the procedure in [After working inside your computer](#).

USB Type-C bracket

Removing the Type-C bracket

 **CAUTION:** The information in this removal section is intended for authorized service technicians only.

Prerequisites

1. Follow the procedure in [Before working inside your computer](#).
2. Remove the [base cover](#).

About this task

The following images indicate the location of the Type-C bracket and provide a visual representation of the removal procedure.



3x
M2x4

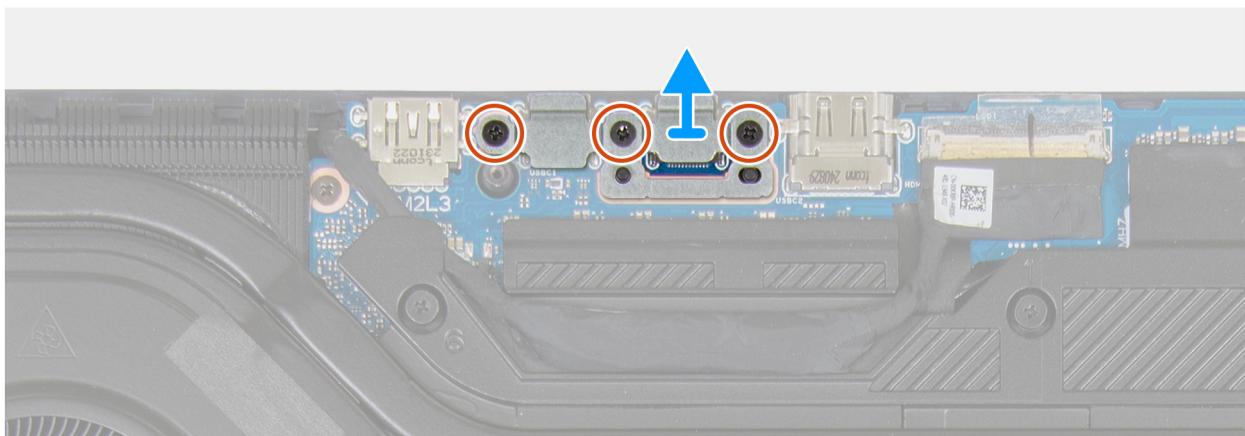

Figure 42. Removing the Type-C bracket

Steps

1. Remove the three screws (M2x4) that secure the Type-C bracket to the palm rest and keyboard assembly.
2. Lift the Type-C bracket from the system board.

Installing the Type-C bracket

CAUTION: The information in this installation section is intended for authorized service technicians only.

Prerequisites

If you are replacing a component, remove the existing component before performing the installation process.

About this task

The following images indicate the location of the Type-C bracket and provide a visual representation of the installation procedure.

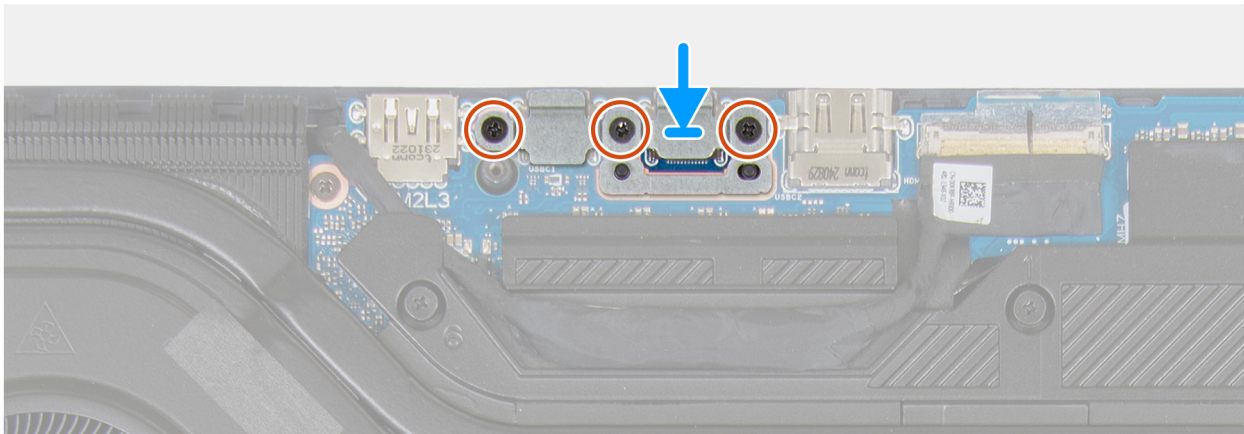

Figure 43. Installing the Type-C bracket

Steps

1. Using the alignment post, place the Type-C bracket on the system board.
2. Align the screw holes on the Type-C bracket with the screw holes on the palm rest and keyboard assembly.
3. Replace the three screws (M2x4) that secure the Type-C bracket to the palm rest and keyboard assembly.

Next steps

1. Install the [base cover](#).
2. Follow the procedure in [After working inside your computer](#).

Battery bracket

Removing the 3-cell battery brackets

CAUTION: The information in this removal section is intended for authorized service technicians only.

Prerequisites

1. Follow the procedure in [Before working inside your computer](#).
2. Remove the [base cover](#).
3. Remove the [battery](#).

About this task

The following images indicate the location of the 3-cell battery bracket and provide a visual representation of the removal procedure.

NOTE: Removing the battery resets the BIOS setup menu settings to default. It is recommended that you note down the BIOS setup menu settings before removing the battery.

The following images indicate the location of the 3-cell battery brackets and provide a visual representation of the removal procedure.



4x
M2x2.5

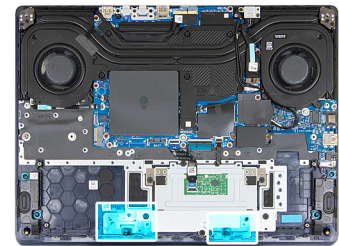

Figure 44. Removing the 3-cell battery brackets

Steps

1. Remove the four screws (M2x2.5) that secure the battery brackets to the palm rest and keyboard assembly.
2. Remove the battery brackets from the palm rest and keyboard assembly.

Installing the 3-cell battery brackets

CAUTION: The information in this installation section is intended for authorized service technicians only.

Prerequisites

If you are replacing a component, remove the existing component before performing the installation procedure.

About this task

The following images indicate the location of the 3-cell battery cables and provide a visual representation of the installation procedure.



4x
M2x2.5

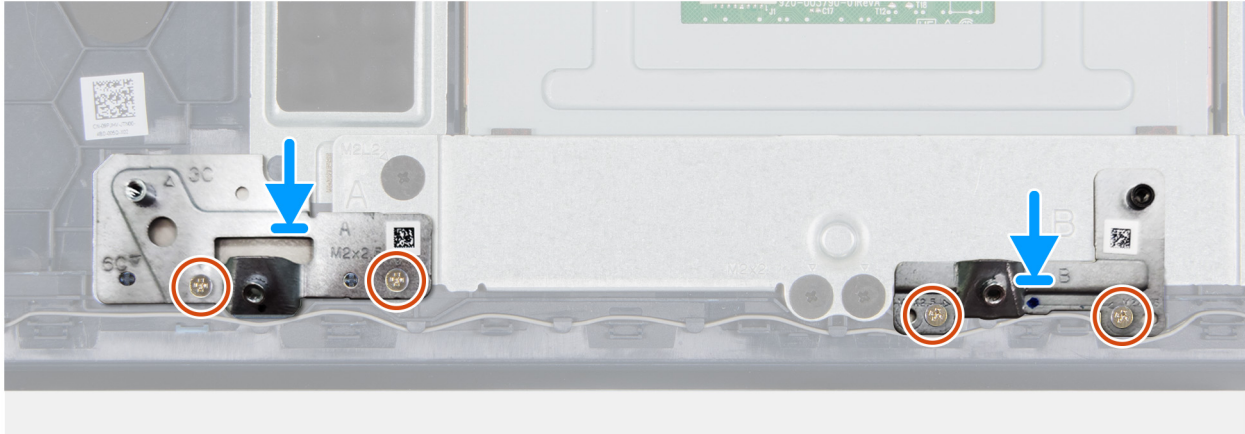
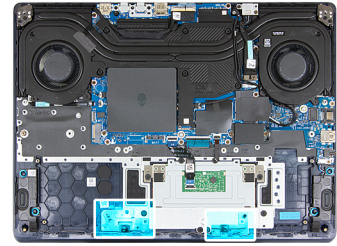

Figure 45. Installing the 3-cell battery brackets

Steps

1. Align the screw holes on bracket A with the screw holes on the palm rest and keyboard assembly.
2. Replace the two screws (M2x2.5) that secure the bracket to the palm rest and keyboard assembly.
3. Align the screw holes on bracket B with the screw holes on the palm rest and keyboard assembly.
4. Replace the two screws (M2x2.5) that secure the bracket to the palm rest and keyboard assembly.

Next steps

1. Install the [battery](#).
2. Install the [base cover](#).
3. Follow the procedure in [After working inside your computer](#).

Removing the 6-cell battery brackets

 **CAUTION:** The information in this removal section is intended for authorized service technicians only.

Prerequisites

1. Follow the procedure in [Before working inside your computer](#).
2. Remove the [base cover](#).
3. Remove the [battery](#).

About this task

The following images indicate the location of the 6-cell battery bracket and provide a visual representation of the removal procedure.

 **NOTE:** Removing the battery resets the BIOS setup menu settings to default. It is recommended that you note down the BIOS setup menu settings before removing the battery.

The following images indicate the location of the 6-cell battery brackets and provide a visual representation of the removal procedure.



4x
M2x2.5

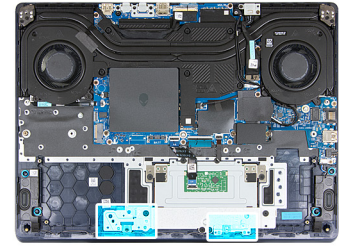

Figure 46. Removing the 6-cell battery brackets

Steps

1. Remove the four screws (M2x2.5) that secure the battery brackets to the palm rest and keyboard assembly.
2. Remove the battery brackets away from the palm rest and keyboard assembly.

Installing the 6-cell battery brackets

CAUTION: The information in this installation section is intended for authorized service technicians only.

Prerequisites

If you are replacing a component, remove the existing component before performing the installation procedure.

About this task

The following images indicate the location of the 6-cell battery cables and provide a visual representation of the installation procedure.



4x
M2x2.5

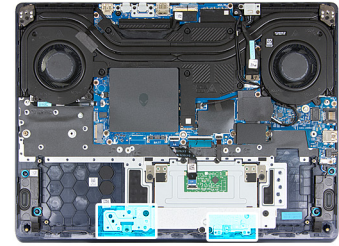

Figure 47. Installing the 6-cell battery brackets

Steps

1. Align the screw holes on bracket A with the screw holes on the palm rest and keyboard assembly.
2. Replace the two screws (M2x2.5) that secure the bracket to the palm rest and keyboard assembly.
3. Align the screw holes on bracket B with the screw holes on the palm rest and keyboard assembly.
4. Replace the two screws (M2x2.5) that secure the bracket to the palm rest and keyboard assembly.

Next steps

1. Install the [battery](#).
2. Install the [base cover](#).
3. Follow the procedure in [After working inside your computer](#).

Touchpad

Removing the touchpad

CAUTION: The information in this removal section is intended for authorized service technicians only.

Prerequisites

1. Follow the procedure in [Before working inside your computer](#).
2. Remove the [base cover](#).
3. Remove the [battery](#).
4. Remove the [battery brackets](#).

About this task

The following images indicate the location of the touchpad and provide a visual representation of the removal procedure.



8x
M2x2

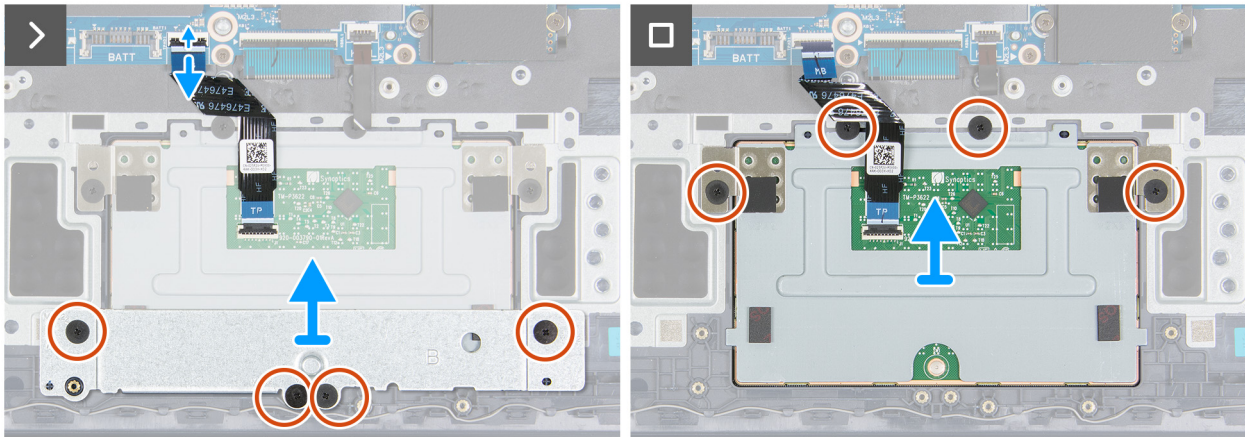
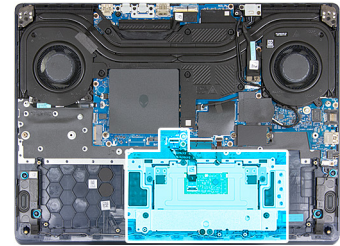

Figure 48. Removing the touchpad

Steps

1. Open the latch and disconnect the touchpad cable from the connector (TPAD1) on the system board.
2. Remove the four screws (M2x2) that secure the touchpad support plate to the palm rest and keyboard assembly.
3. Lift the touchpad support plate from the palm rest and keyboard assembly.
4. Remove the four screws (M2x2) that secure the touchpad to the palm rest and keyboard assembly.
5. Lift the touchpad from the palm rest and keyboard assembly.

Installing the touchpad

CAUTION: The information in this installation section is intended for authorized service technicians only.

Prerequisites

If you are replacing a component, remove the existing component before performing the installation process.

About this task

The following images indicate the location of the touchpad and provide a visual representation of the installation procedure.



8x
M2x2

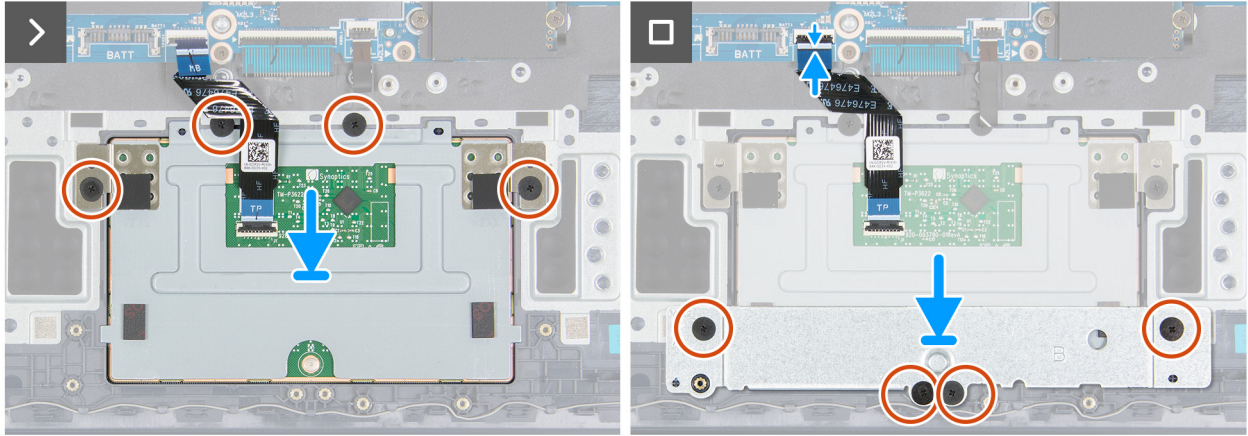
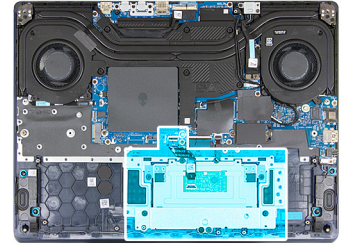

Figure 49. Installing the touchpad

Steps

1. At an angle slide the touchpad into the slot on the palm rest and keyboard assembly.
2. Turn the computer over and open the display to ensure that the touchpad is equally aligned on all sides.
3. Close the display and turn the computer over.
4. Replace the four screws (M2x2) that secure the touchpad to the palm rest and keyboard assembly.
5. Align the screw holes on the touchpad support plate with the screw holes on the palm rest and keyboard assembly.
6. Replace the four screws (M2x2) that secure the touchpad support plate to the palm rest and keyboard assembly.
7. Slide the touchpad cable into the connector (TPAD1) on the system board and close the latch to secure the cable.

Next steps

1. Install the [battery brackets](#).
2. Install the [battery](#).
3. Install the [base cover](#).
4. Follow the procedure in [After working inside your computer](#).

Power button and power-button board

Removing the power button and power-button board

 **CAUTION:** The information in this removal section is intended for authorized service technicians only.

Prerequisites

1. Follow the procedure in [Before working inside your computer](#).
2. Remove the [base cover](#).
3. Remove the [wireless card](#).
4. Remove the [power-adaptor port](#).
5. Follow the procedures from step 1 to step 7 in [Removing the system board](#).

NOTE: The system board can be removed as an assembly with the fan and heat-sink assembly to preserve the thermal bond between the system board and fan and heat-sink assembly.

About this task

The following images indicate the location of the power button and power-button board and provide a visual representation of the removal procedure.

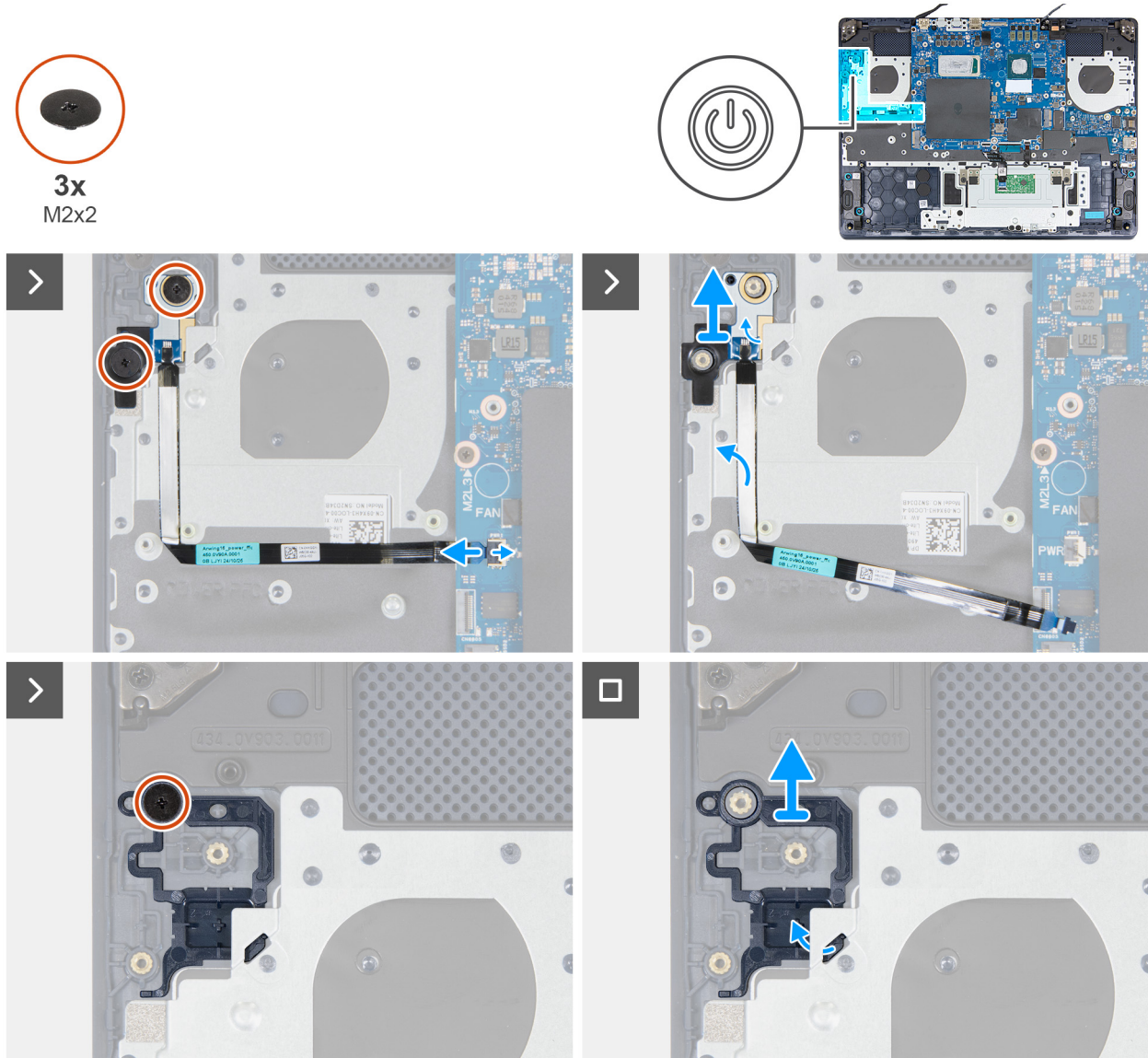

Figure 50. Removing the power button and power-button board

Steps

1. Remove the two screws (M2x2) that secure the power-button board to the palm rest and keyboard assembly.
2. Open the latch and disconnect the power-button cable from the connector (PWR1) on the system board.
3. Lift the power-button board along with its cable off the palm rest and keyboard assembly.
4. Remove the screw (M2x2) that secures the power button to the palm rest and keyboard assembly.
5. Lift the power button off the palm rest and keyboard assembly.

Installing the power button and power-button board

CAUTION: The information in this installation section is intended for authorized service technicians only.

Prerequisites

If you are replacing a component, remove the existing component before performing the installation process.

About this task

The following images indicate the location of the power button and power-button board and provide a visual representation of the installation procedure.

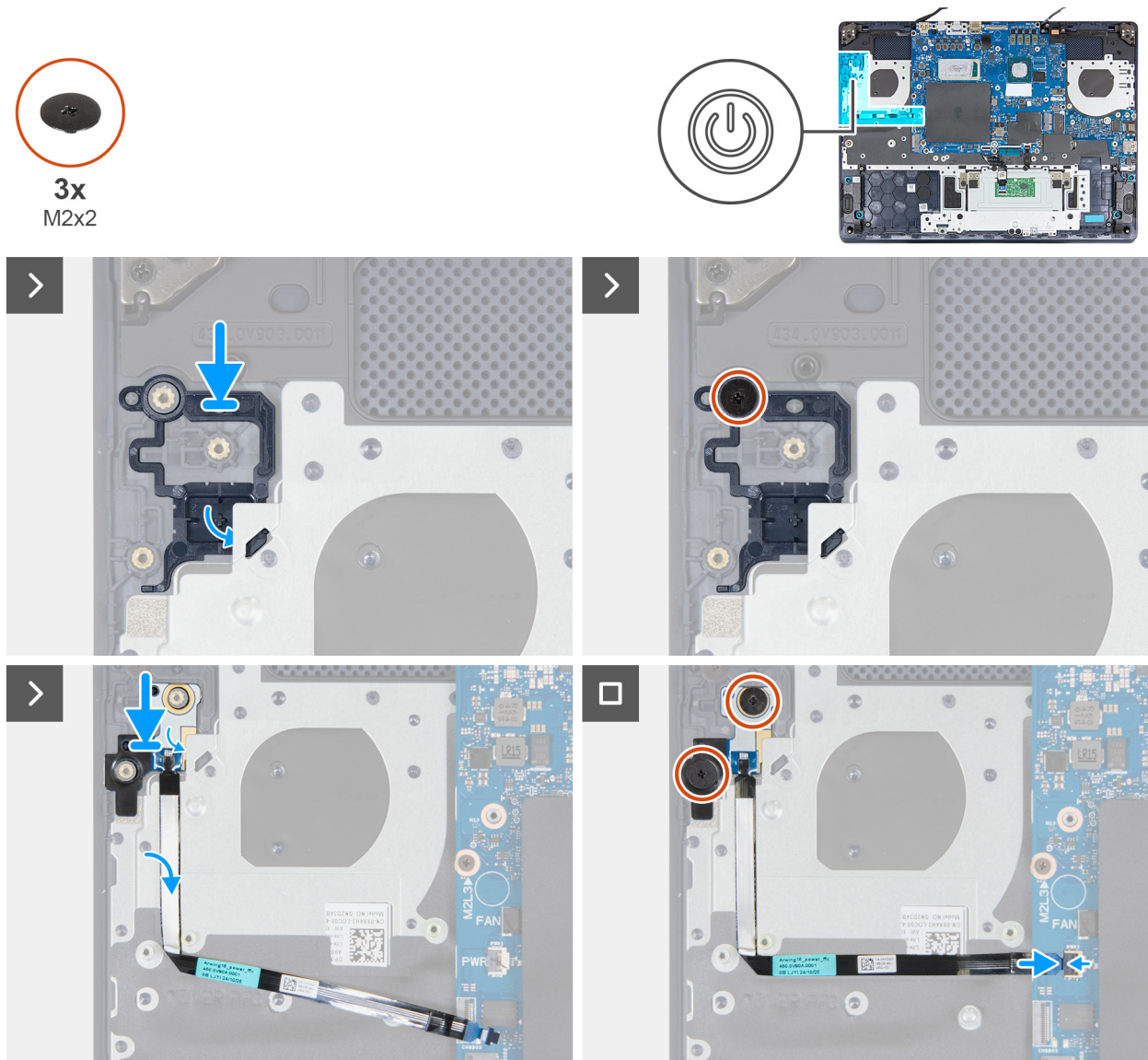

Figure 51. Installing the power button and power-button board

Steps

1. Align and slide the power button into the slot on the palm rest and keyboard assembly.
2. Align the screw hole on the power button with the screw hole on the palm rest and keyboard assembly.
3. Replace the screw (M2x2) that secures the power button to the palm rest and keyboard assembly.
4. Align the screw holes on the power-button board with the screw holes on the palm rest and keyboard assembly.
5. Replace the two screws (M2x2) that secure the power-button board to the palm rest and keyboard assembly.

6. Adhere the power-button board cable to the palm rest and keyboard assembly.
7. Connect the power-button cable to the connector (PWR1) on the system board.

Next steps

1. Follow the procedures from Step 4 to 10 in [Installing the system board](#).

 **NOTE:** The system board can be installed as an assembly with the fan and heat-sink assembly to preserve the thermal bond between the system board and fan and heat-sink assembly.

2. Install the [power-adapter port](#).
3. Install the [wireless card](#).
4. Install the [base cover](#).
5. Follow the procedure in [After working inside your computer](#).

System board

Removing the system board

 **CAUTION:** The information in this removal section is intended for authorized service technicians only.

Prerequisites

1. Follow the procedure in [Before working inside your computer](#).
2. Remove the [base cover](#).
3. Remove the [battery](#).
4. Remove the [memory](#).
5. Remove the [solid state drive](#).
6. Remove the [wireless card](#).
7. Remove the [power-adapter port](#).
8. Remove the [fan and heat-sink assembly](#).
9. Remove the [Type-C bracket](#).

About this task

The following image indicates the connectors on your system board.

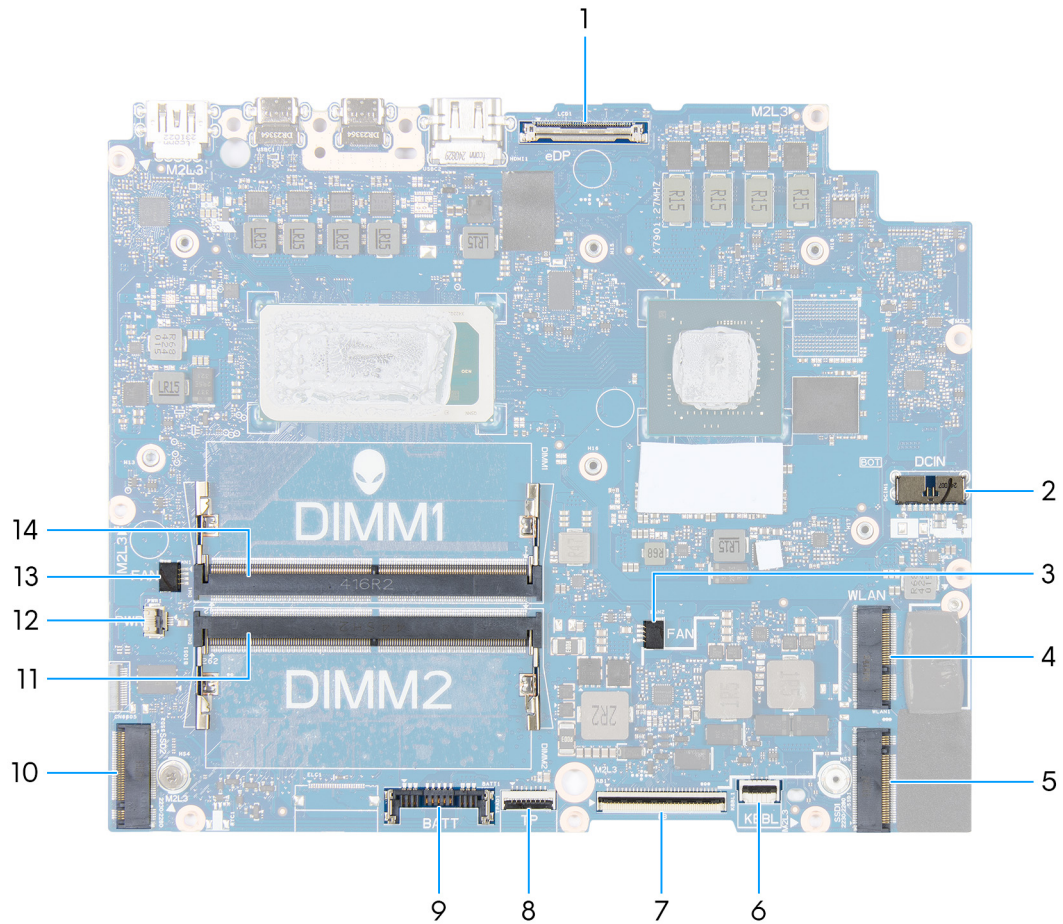

Figure 52. System-board connectors

1. Display-cable connector (LCD1)
2. Power-adapter port cable connector (DCIN)
3. Left fan-cable connector (FAN2)
4. Wireless-card slot (WLAN1)
5. M2.2230 solid state drive (SSD1)
6. Keyboard-backlight cable connector (KBBL1)
7. Keyboard-controller cable connector (KB)
8. Touchpad cable connector (TPAD1)
9. Battery-cable connector (BATT1)
10. M2.2230 solid state drive (SSD2)
11. Memory-module slot (DIMM2)
12. Power-button cable connector (PWR1)
13. Right fan-cable connector (FAN1)
14. Memory-module slot (DIMM1)

The following images indicate the location of the system board and provide a visual representation of the removal procedure.



10x
M2x3

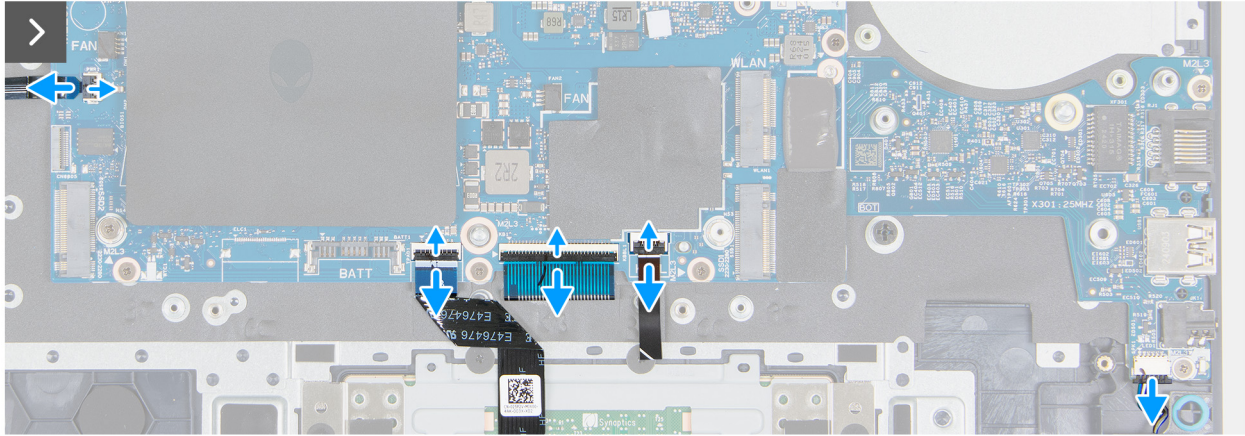
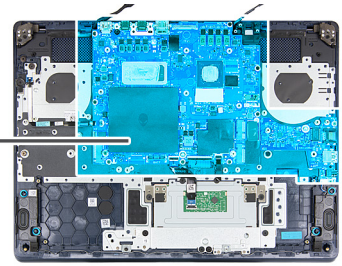

Figure 53. Removing the system board

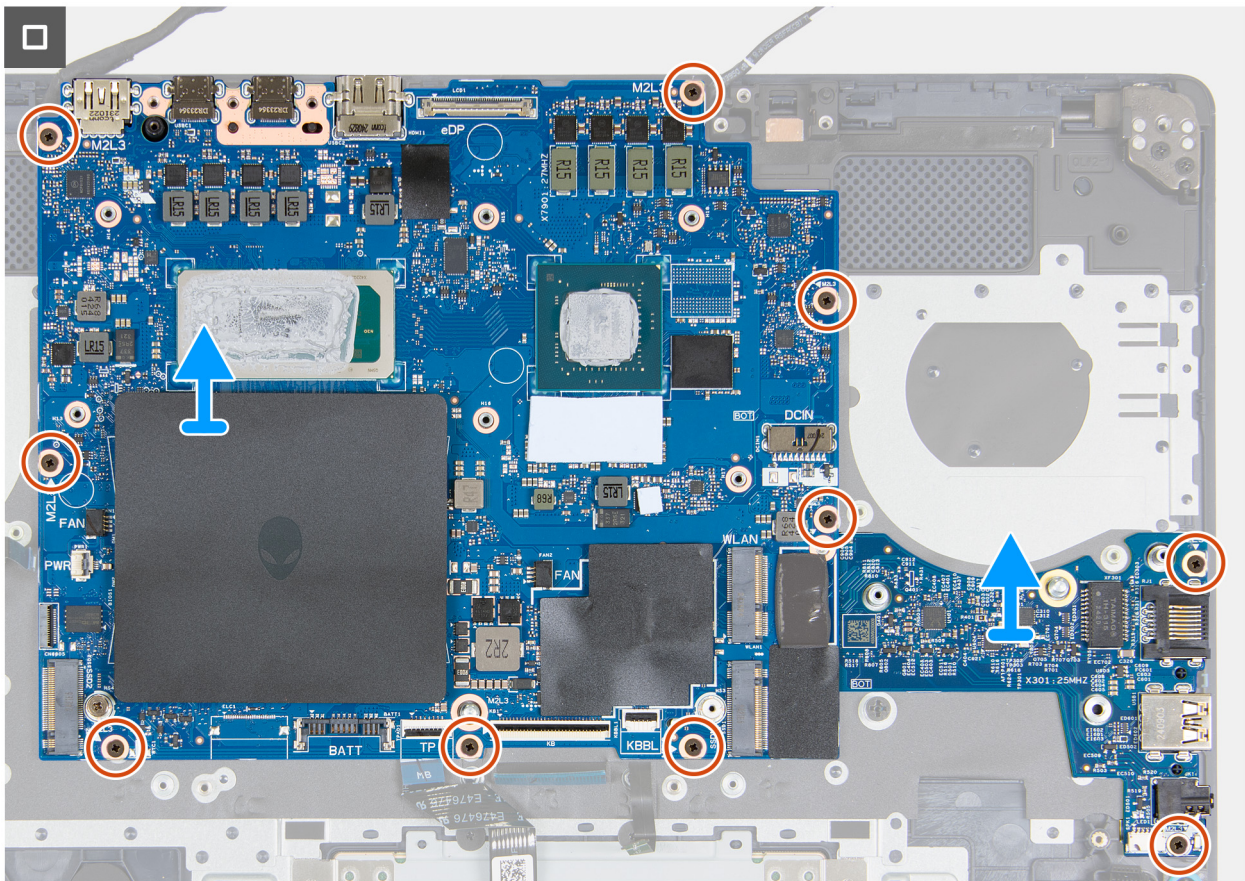

Figure 54. Removing the system board

Steps

1. Open the latch and disconnect the power-button cable from the connector (PWR1) on the system board.

2. Open the latch and disconnect the touchpad cable from the connector (TPAD1) on the system board.
3. Open the latch and disconnect the keyboard-controller cable from the connector (KB) on the system board.
4. Open the latch and disconnect the keyboard-backlight cable from the connector (KBBL1) on the system board.
5. Disconnect the speaker cable from the connector (SPK1) on the I/O board.
6. Remove the ten screws (M2x3) that secure the system-board assembly to the palm rest and keyboard assembly.
7. Lift the system-board assembly from the palm rest and keyboard assembly and turn it over.
8. Remove the I/O board.
9. After performing all the above steps, you are left with the system board.

Installing the system board

CAUTION: The information in this installation section is intended for authorized service technicians only.

Prerequisites

If you are replacing a component, remove the existing component before performing the installation process.

About this task

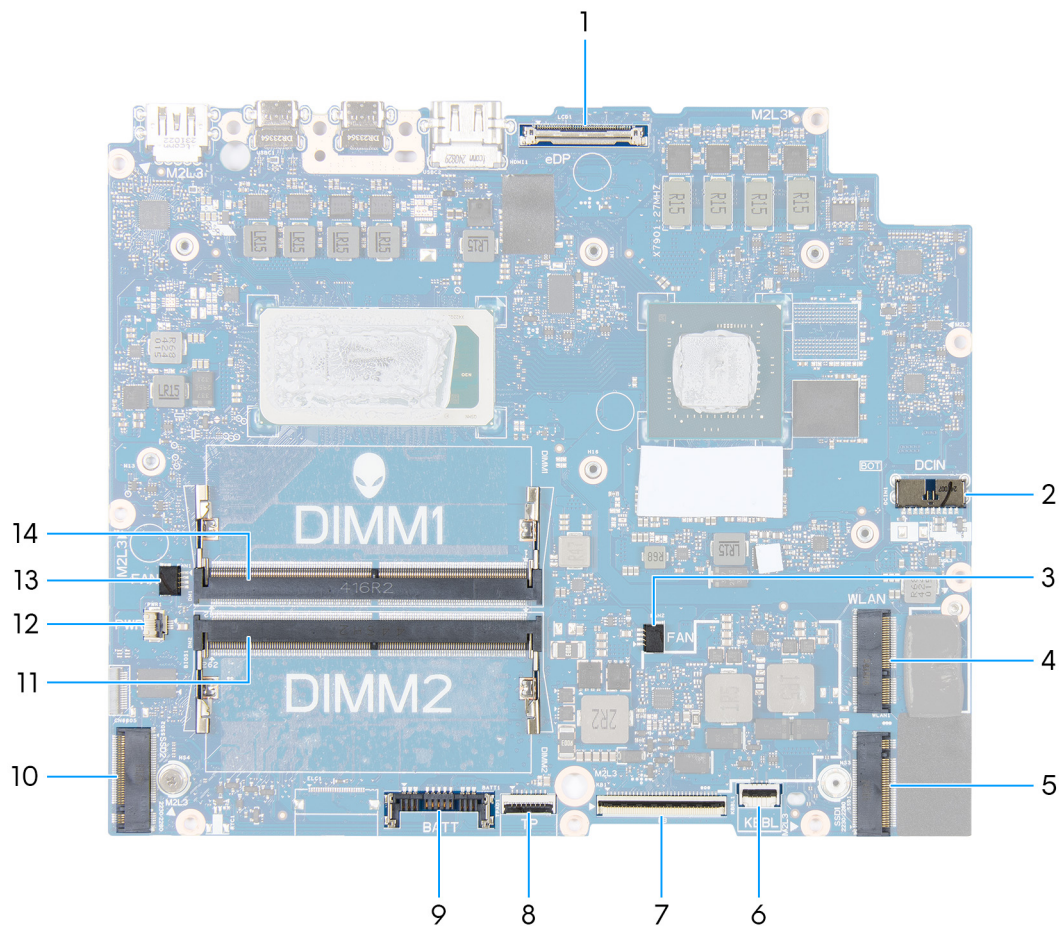

Figure 55. System-board connectors

1. Display-cable connector (LCD1)
2. Power-adaptor port cable connector (DCIN)
3. Left fan-cable connector (FAN2)
4. Wireless-card slot (WLAN1)

5. M2.2230 solid state drive (SSD1)
6. Keyboard-backlight cable connector (KBBL1)
7. Keyboard-controller cable connector (KB)
8. Touchpad cable connector (TPAD1)
9. Battery-cable connector (BATT1)
10. M2.2230 solid state drive (SSD2)
11. Memory-module slot (DIMM2)
12. Power-button cable connector (PWR1)
13. Right fan-cable connector (FAN1)
14. Memory-module slot (DIMM1)

The following images indicate the location of the system board and provide a visual representation of the installation procedure.

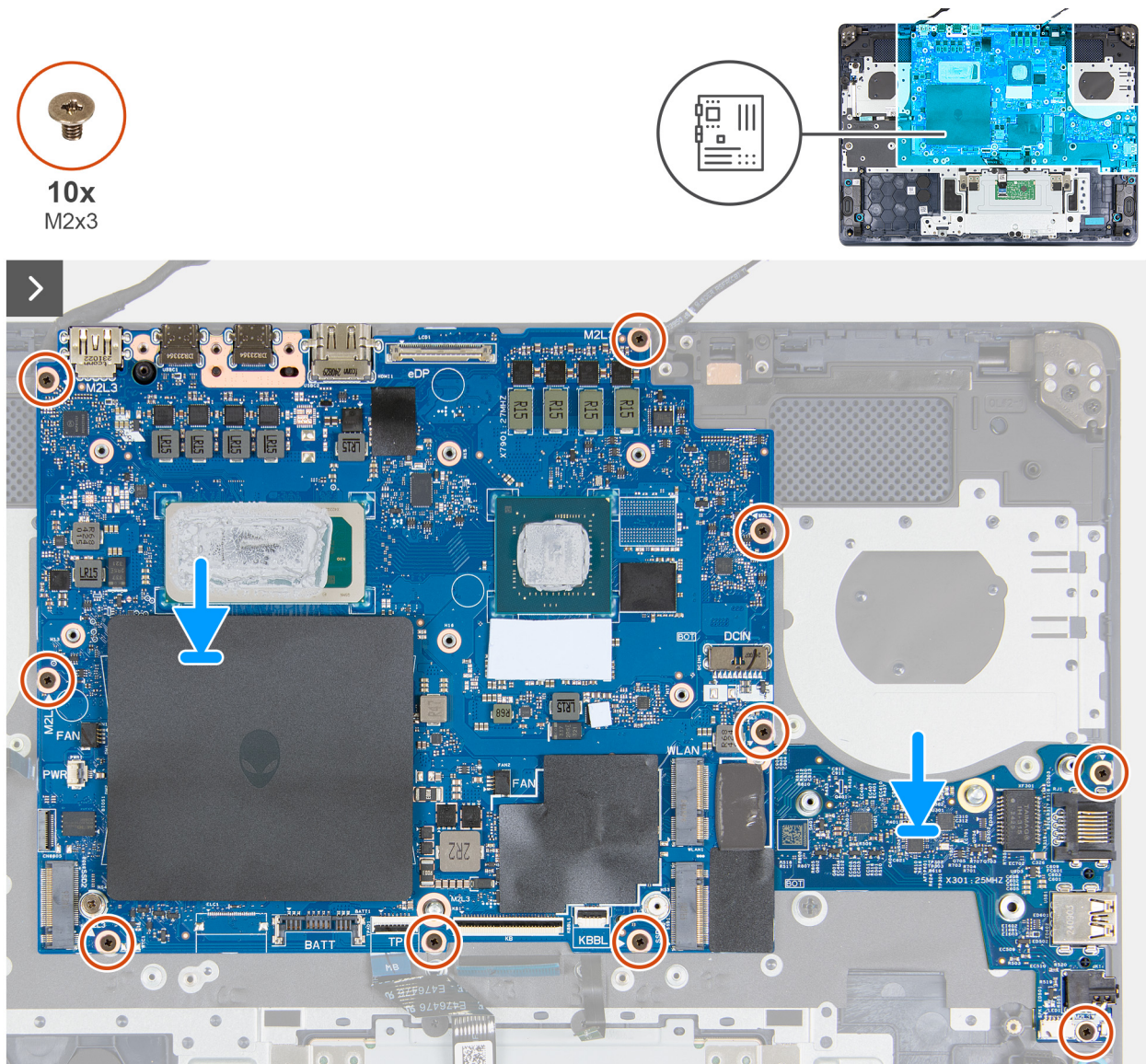

Figure 56. Installing the system board

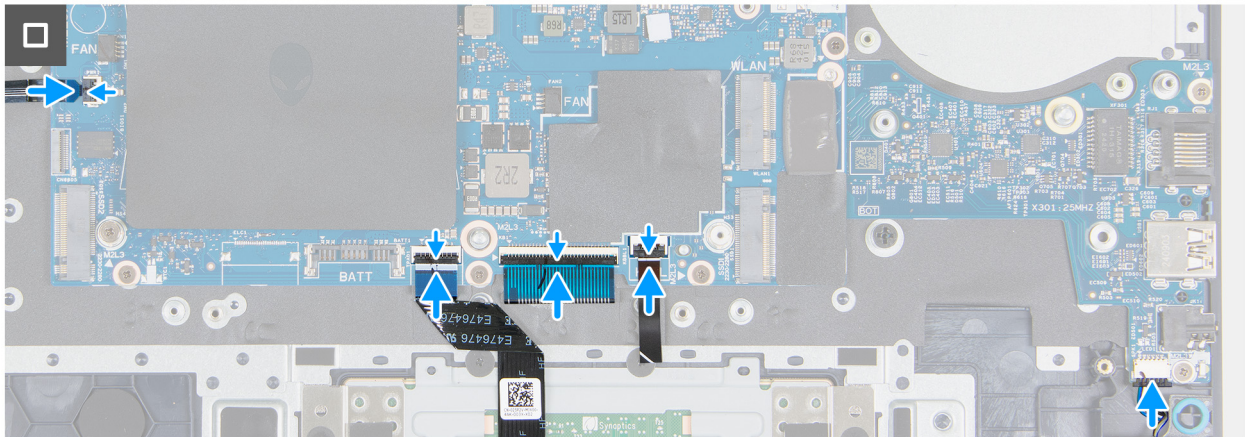

Figure 57. Installing the system board

Steps

1. Turn the system board over.
2. Install the [I/O board](#).
3. Turn the system-board assembly over.
4. Using the alignment posts, place the system-board assembly on the palm rest and keyboard assembly.
5. Replace the ten screws (M2x3) that secure the system board to the palm rest and keyboard assembly.
6. Connect the speaker cable to the connector (SPK1) on the I/O board.
7. Connect the keyboard-backlight cable to the connector (KBBL1) on the system board and close the latch to secure the cable.
8. Connect the keyboard-controller cable to the connector (KB) on the system board and close the latch to secure the cable.
9. Connect the touchpad cable to the connector (TPAD1) on the system board and close the latch to secure the cable.
10. Connect the power-button cable to the connector (PWR1) on the system board and close the latch to secure the cable.

Next steps

1. Install the [Type-C bracket](#).
2. Install the [fan and heat-sink assembly](#).
3. Install the [power-adaptor port](#).
4. Install the [wireless card](#).
5. Install the [solid state drive](#).
6. Install the [memory](#).
7. Install the [battery](#).
8. Install the [base cover](#).
9. Follow the procedure in [After working inside your computer](#).

I/O board

Removing the I/O board

CAUTION: The information in this removal section is intended for authorized service technicians only.

Prerequisites

1. Follow the procedure in [Before working inside your computer](#).
2. Remove the [base cover](#).
3. Remove the [battery](#).
4. Remove the [memory](#).
5. Remove the [solid state drive](#).

6. Remove the [wireless card](#).
7. Remove the [power-adapter port](#).
8. Remove the [Type-C bracket](#).
9. Follow the procedures from step 1 to step 7 in [Removing the system board](#).

NOTE: The system board can be removed as an assembly with the fan and heat-sink assembly to preserve the thermal bond between the system board and fan and heat-sink assembly.

About this task

The following images indicate the location of the I/O board and provide a visual representation of the removal procedure.

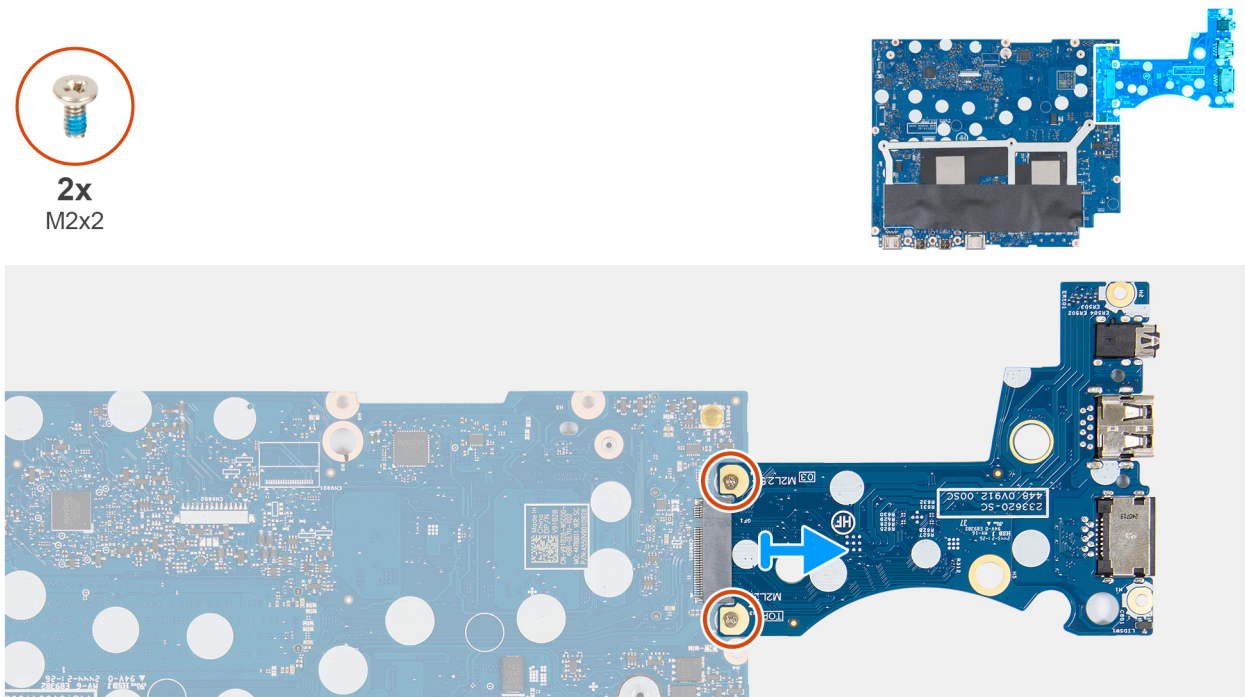

Figure 58. Removing the I/O board

Steps

1. Lift the system-board assembly from the palm rest and keyboard assembly and turn it over.
2. Remove the two screws (M2x2) that secure the I/O board to the system board.
3. Lift the I/O board from the system board.

Installing the I/O board

CAUTION: The information in this installation section is intended for authorized service technicians only.

Prerequisites

If you are replacing a component, remove the existing component before performing the installation process.

About this task

The following images indicate the location of the I/O board and provide a visual representation of the installation procedure.



2x
M2x2

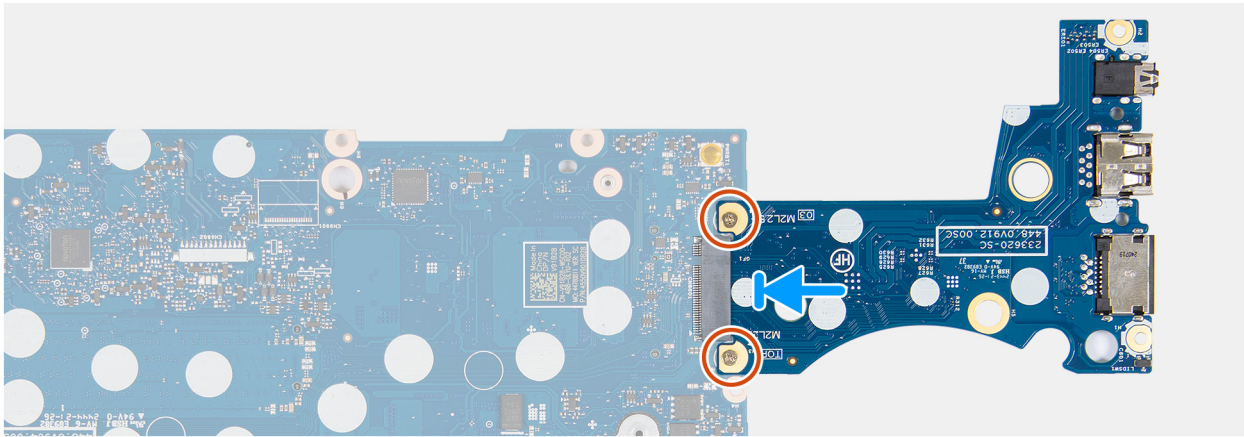
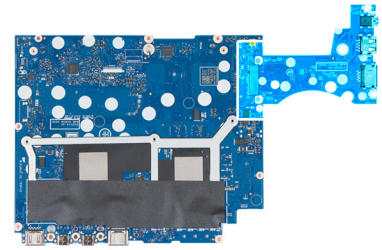

Figure 59. Installing the I/O board

Steps

1. Align the screw holes on the I/O board with the screw holes on the system board.
2. Replace the two screws (M2x2) that secure the I/O board to the system board.
3. Lift the system-board assembly and turn it over.

Next steps

1. Follow the procedures from Step 4 to 10 in [Installing the system board](#).

NOTE: The system board can be installed as an assembly with the fan and heat-sink assembly to preserve the thermal bond between the system board and fan and heat-sink assembly.

2. Install the [power-adapter port](#).
3. Install the [wireless card](#).
4. Install the [solid state drive](#).
5. Install the [memory](#).
6. Install the [battery](#).
7. Install the [base cover](#).
8. Follow the procedure in [After working inside your computer](#).

Rear cap

Removing the rear cap

CAUTION: The information in this removal section is intended for authorized service technicians only.

Prerequisites

1. Follow the procedure in [Before working inside your computer](#).
2. Remove the [base cover](#).

About this task

The following images indicate the location of the rear cap and provide a visual representation of the removal procedure.



5x
M2x3.5

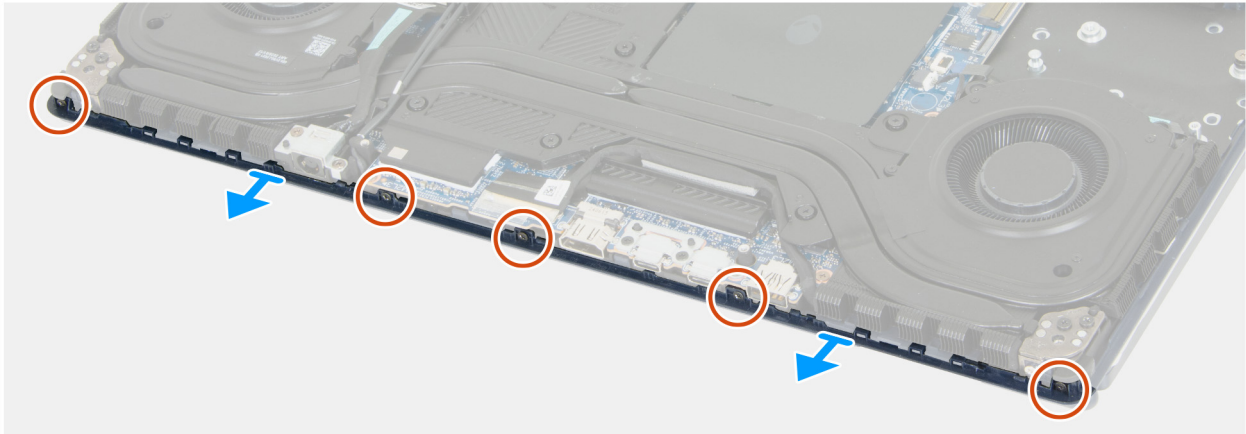
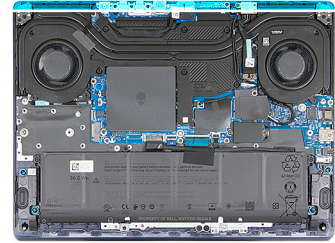

Figure 60. Removing the rear cap

Steps

1. Remove the five screws (M2x3.5) that secure the rear cap to the palm rest and keyboard assembly.

NOTE: Do not remove the two silver-colored screws that secure the display assembly to the palm rest and keyboard assembly.



Figure 61. Screws that should not be removed

2. Lift the rear cap off the palm rest and keyboard assembly.

Installing the rear cap

CAUTION: The information in this installation section is intended for authorized service technicians only.

Prerequisites

If you are replacing a component, remove the existing component before performing the installation process.

About this task

The following images indicate the location of the rear cap and provide a visual representation of the installation procedure.



5x
M2x3.5

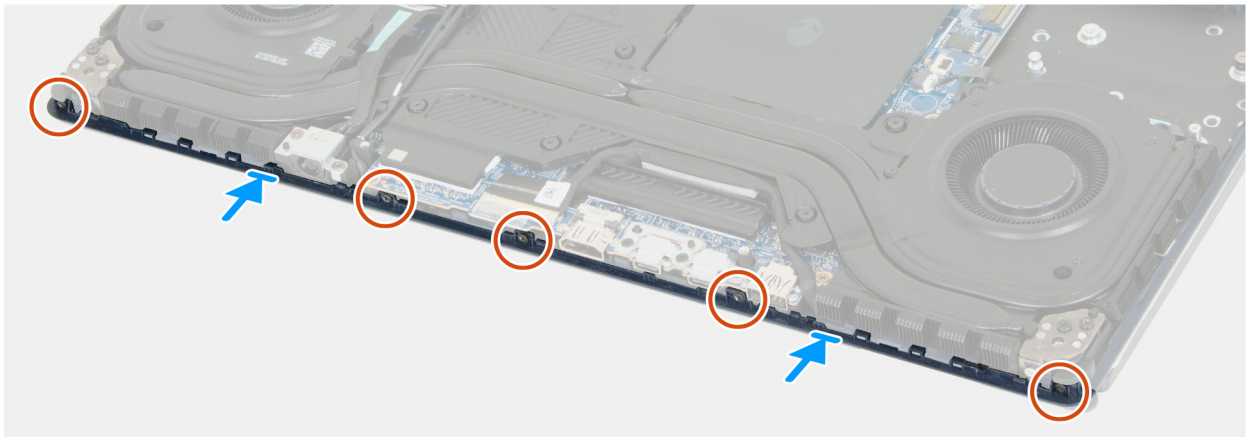
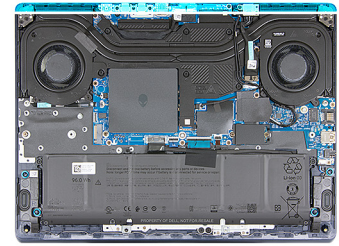

Figure 62. Installing the rear cap

Steps

1. Align the screw holes on the rear cap with the screw holes on the palm rest and keyboard assembly.
2. Replace the five screws (M2x3.5) that secure the rear cap to the palm rest and keyboard assembly.

Next steps

1. Install the [base cover](#).
2. Follow the procedure in [After working inside your computer](#).

Center bar

Removing the center bar

CAUTION: The information in this removal section is intended for authorized service technicians only.

Prerequisites

1. Follow the procedure in [Before working inside your computer](#).
2. Remove the [base cover](#).
3. Remove the [rear cap](#).

About this task

The following images indicate the location of the center bar and provide a visual representation of the removal procedure.



2x
M2x3.5

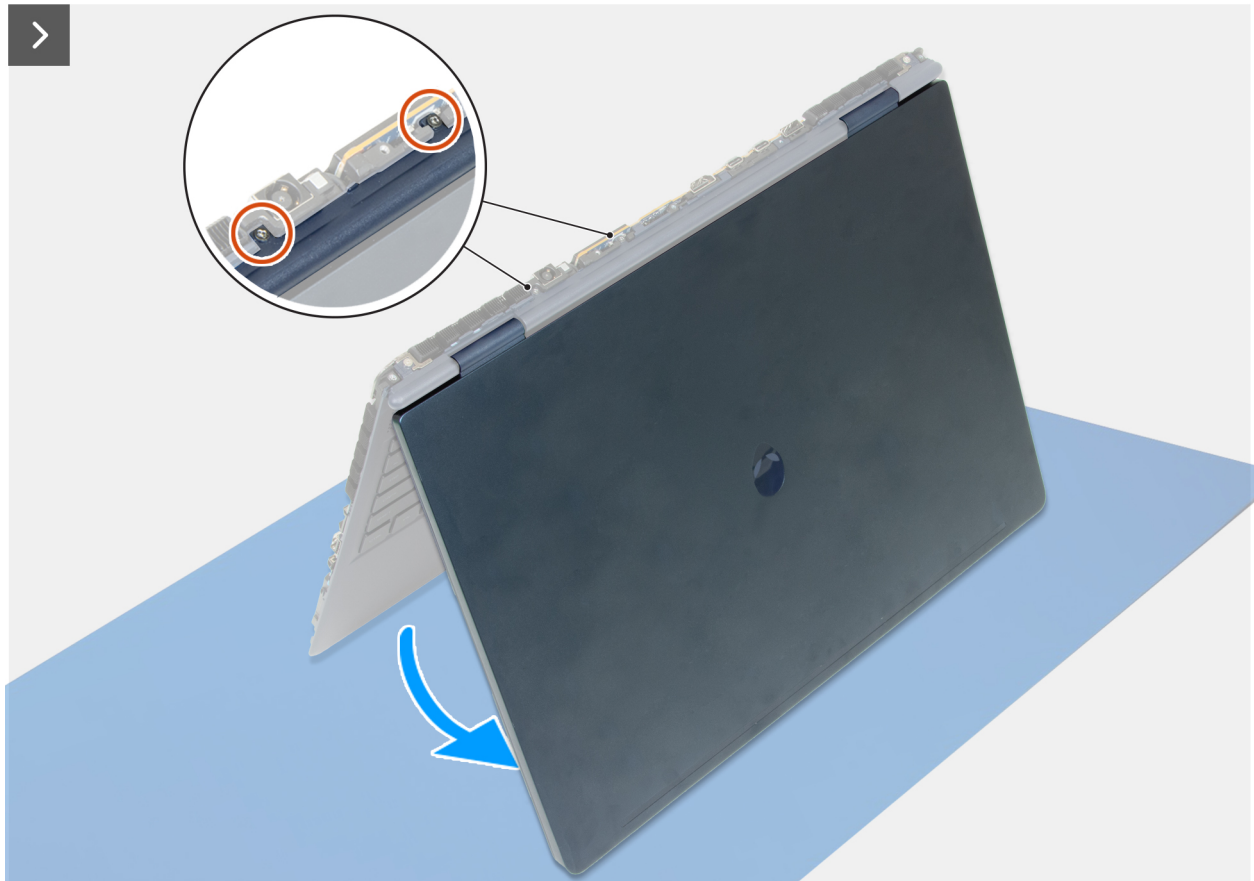
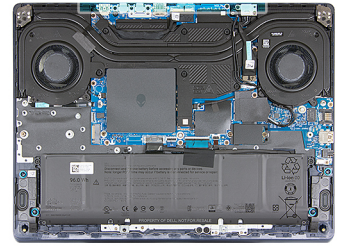

Figure 63. Removing the center bar

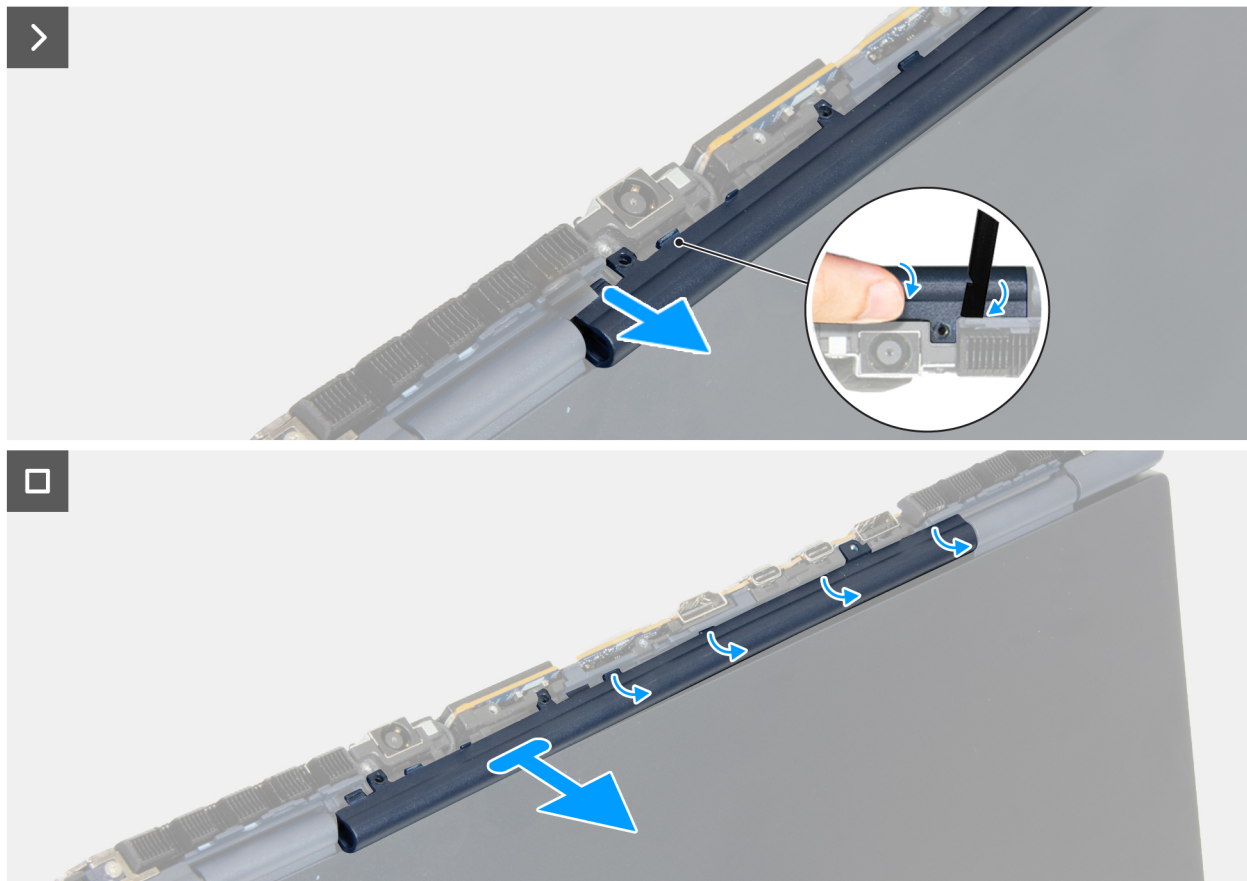

Figure 64. Removing the center bar

Steps

1. Lay an ESD protection mat on a clean and flat surface.
2. Open the display lid of the computer and place it upright in a tent configuration on the ESD protection mat.
3. Remove the two screws (M2x3.5) that secure the center bar to the palm rest and keyboard assembly.
4. With a finger, apply pressure at the location shown above the power-adaptor port.
5. Insert a scribe into the gap that is created in the location shown to disengage the securing hook.
6. Gently pry the center bar away from the palm rest and keyboard assembly.
7. Lift the center bar off the palm rest and keyboard assembly.
8. Close the display lid and place the computer with the lid facing downwards on a clean and flat surface.

Installing the center bar

CAUTION: The information in this installation section is intended for authorized service technicians only.

Prerequisites

If you are replacing a component, remove the existing component before performing the installation process.

About this task

The following images indicate the location of the center bar and provide a visual representation of the installation procedure.



2x
M2x3.5

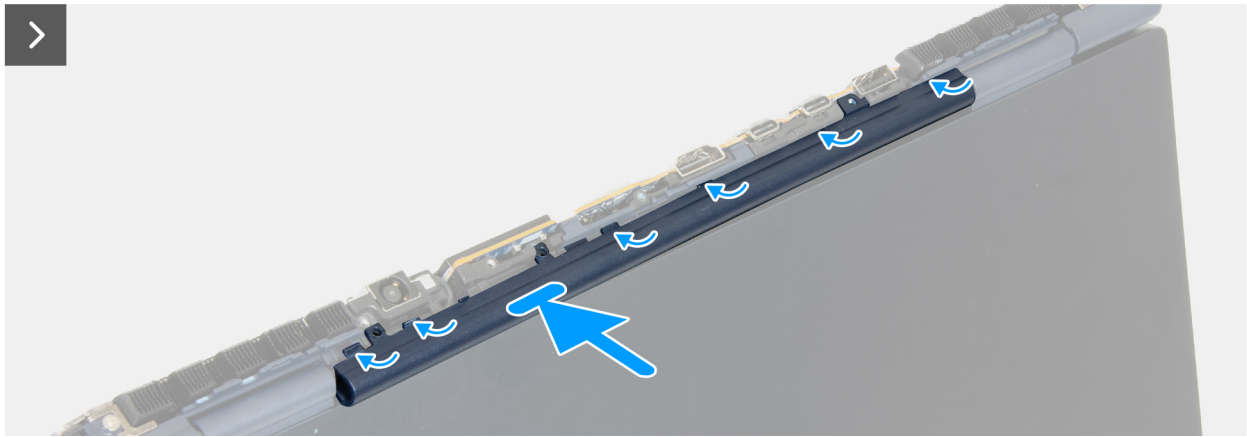
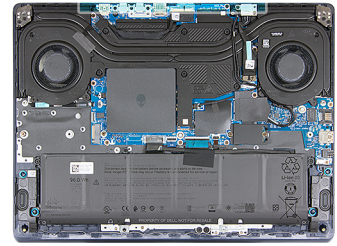

Figure 65. Installing the center bar

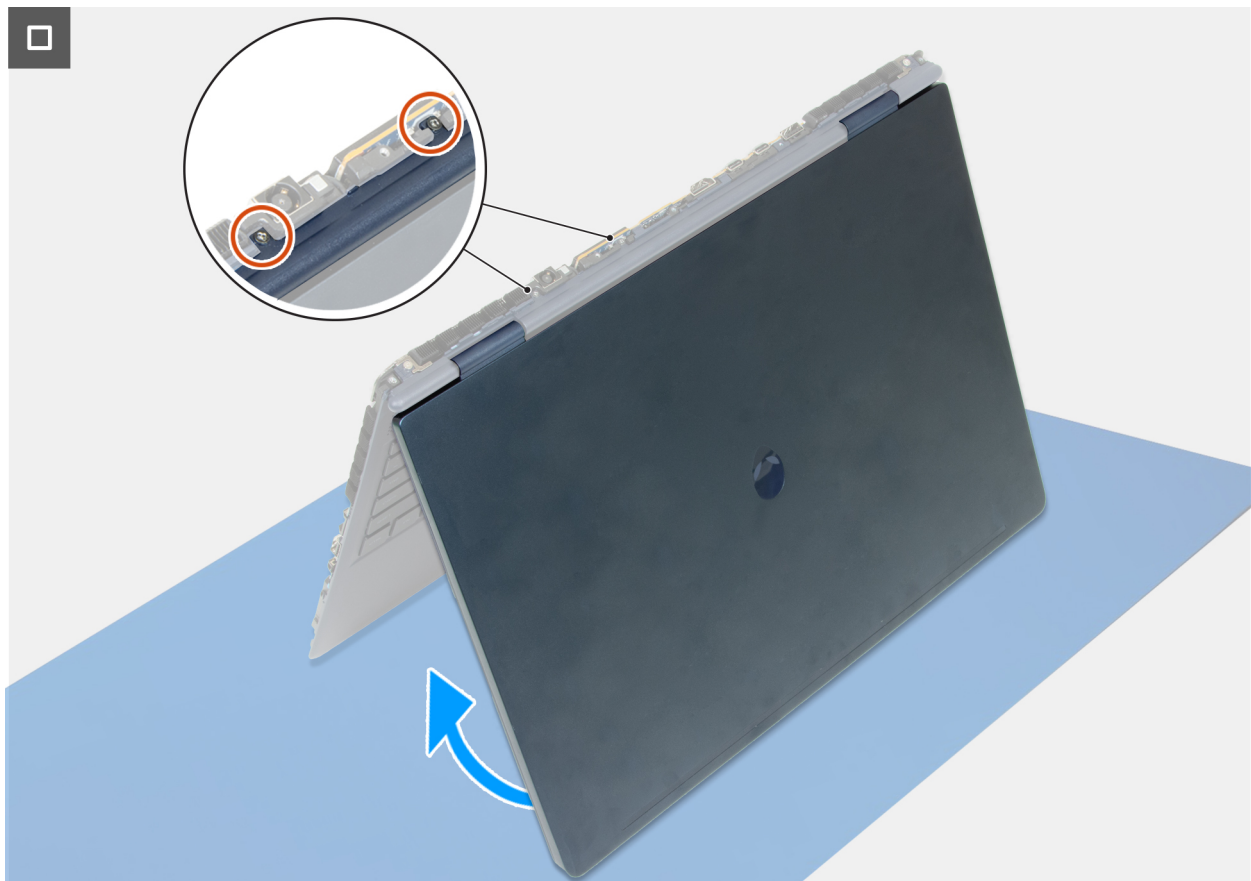



Figure 66. Installing the center bar

Steps

1. Lay an ESD protection mat on a clean and flat surface.

2. Open the display lid of the computer and place it upright in a tent configuration on the ESD protection mat.
3. Snap the center bar into position on the palm rest and keyboard assembly.
 **NOTE:** Ensure the screw holes on the center bar are aligned with the screw holes on the palm rest and keyboard assembly.
4. Replace the two screws (M2x2.5) that secure the center bar to the palm rest and keyboard assembly.
5. Close the display lid and place the computer with the lid facing downwards on a clean and flat surface.

Next steps

1. Install the [rear cap](#).
2. Install the [base cover](#).
3. Follow the procedure in [After working inside your computer](#).

Display assembly

Removing the display assembly

 **CAUTION:** The information in this removal section is intended for authorized service technicians only.

Prerequisites

1. Follow the procedure in [Before working inside your computer](#).
2. Remove the [base cover](#).
3. Remove the [wireless card](#).
4. Remove the [rear cap](#).
5. Remove the [center bar](#).

About this task

The following images indicate the location of the display assembly and provide a visual representation of the removal procedure.



4x
M2.5x5

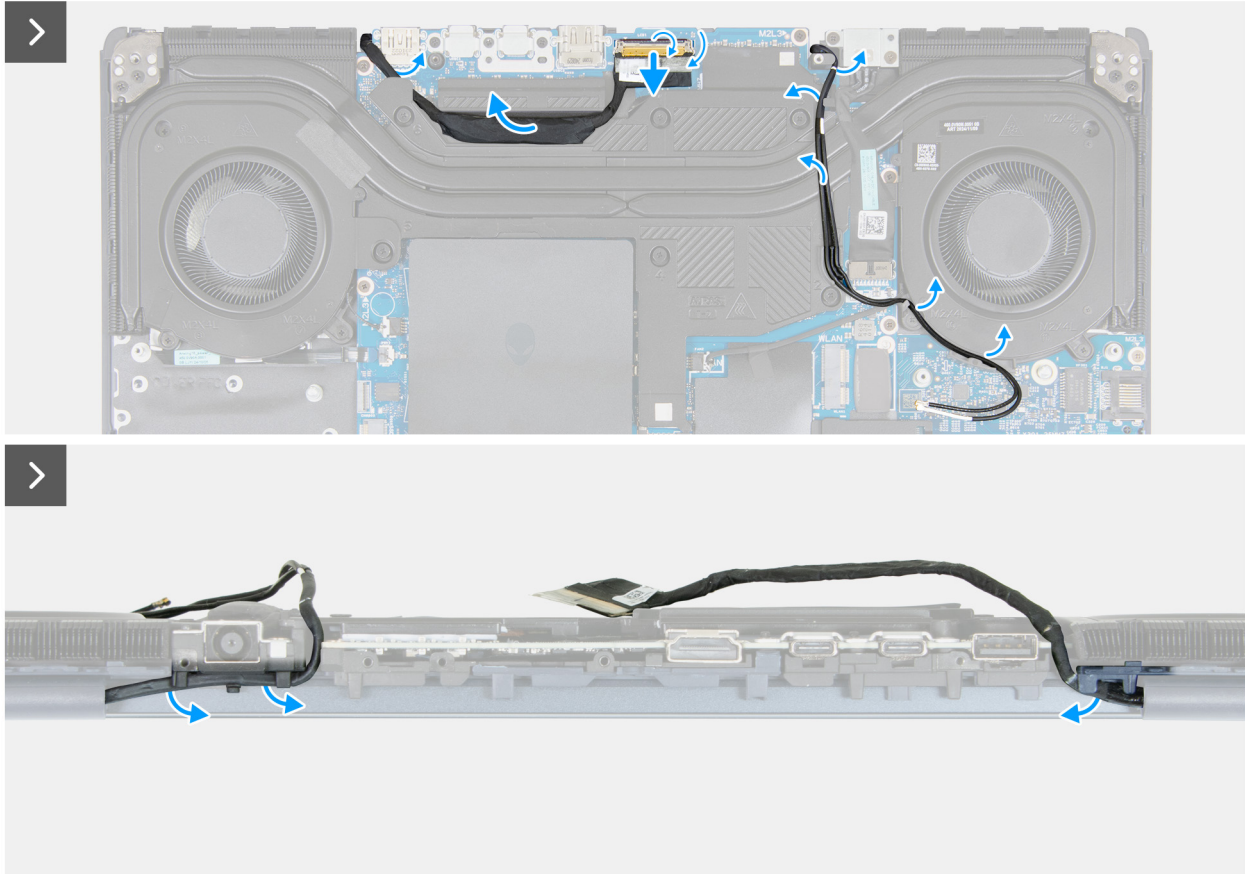
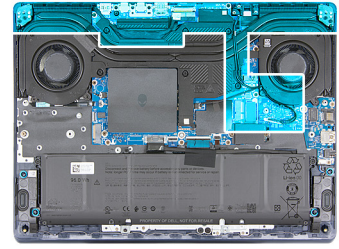

Figure 67. Removing the display assembly

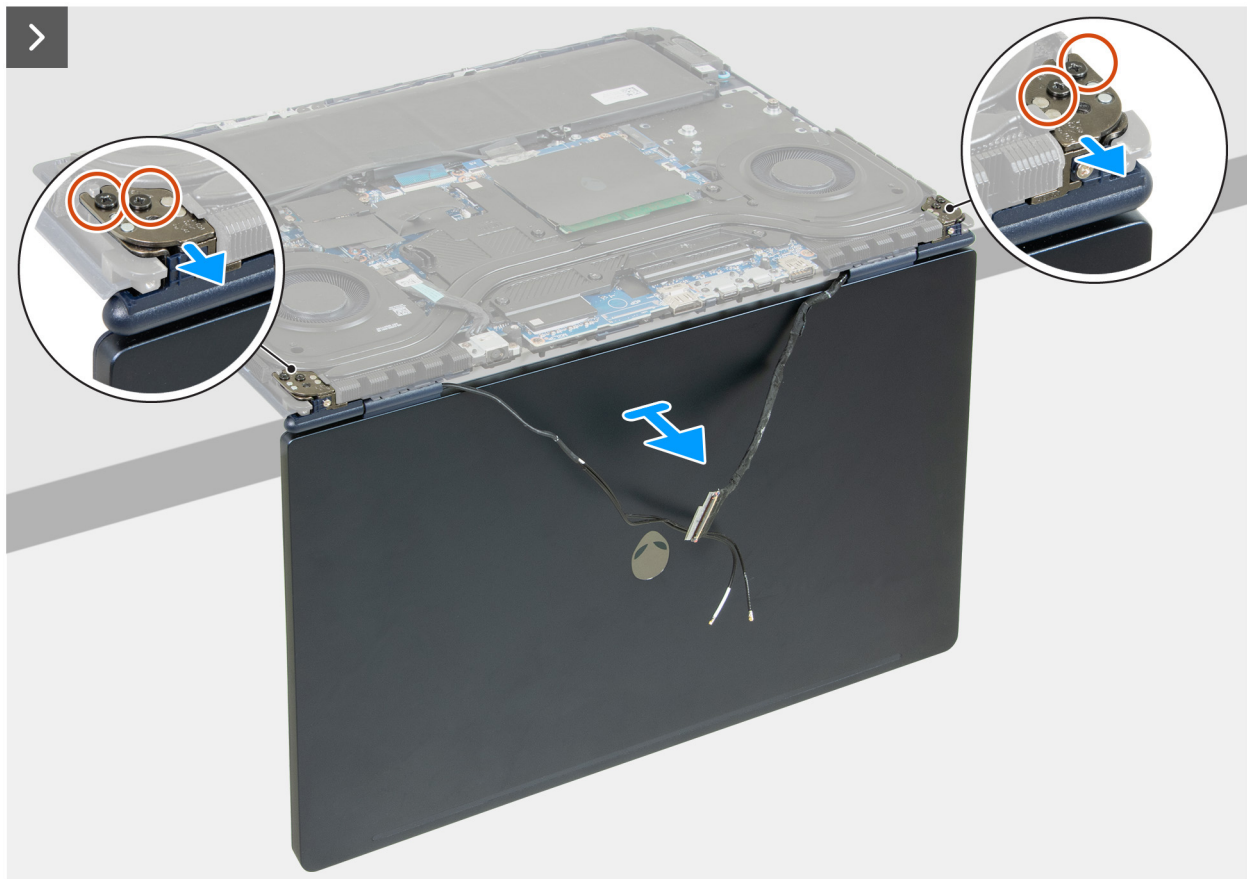

Figure 68. Removing the display assembly

Steps

1. Open the latch and disconnect the display cable from the connector (LCD1) on the system board.
2. Remove the display cable from the routing guides on the palm rest and keyboard assembly.
3. Remove the antenna cables from the routing guides on the fan and heat-sink assembly.
4. Turn the computer to face the rear of the computer.
5. Remove the display cable from the routing guide under the port adapter port.
6. Remove the antenna cables from the routing guide near the right hinge cover.
7. Open the display to a 90-degree angle and place the computer at the edge of a flat table.
8. Remove the two screws (M2.5x5) that secure the right hinge to the palm rest and keyboard assembly.
9. Remove the two screws (M2.5x5) that secure the left hinge to the palm rest and keyboard assembly.
10. Slide the display assembly out from the palm rest and keyboard assembly.
11. After performing all the above steps, you are left with the display assembly.

i NOTE: The display assembly is a Hinge-Up Design (HUD) assembly, which cannot be further disassembled. If any components in the display assembly malfunction and require replacement, the entire display assembly has to be replaced.

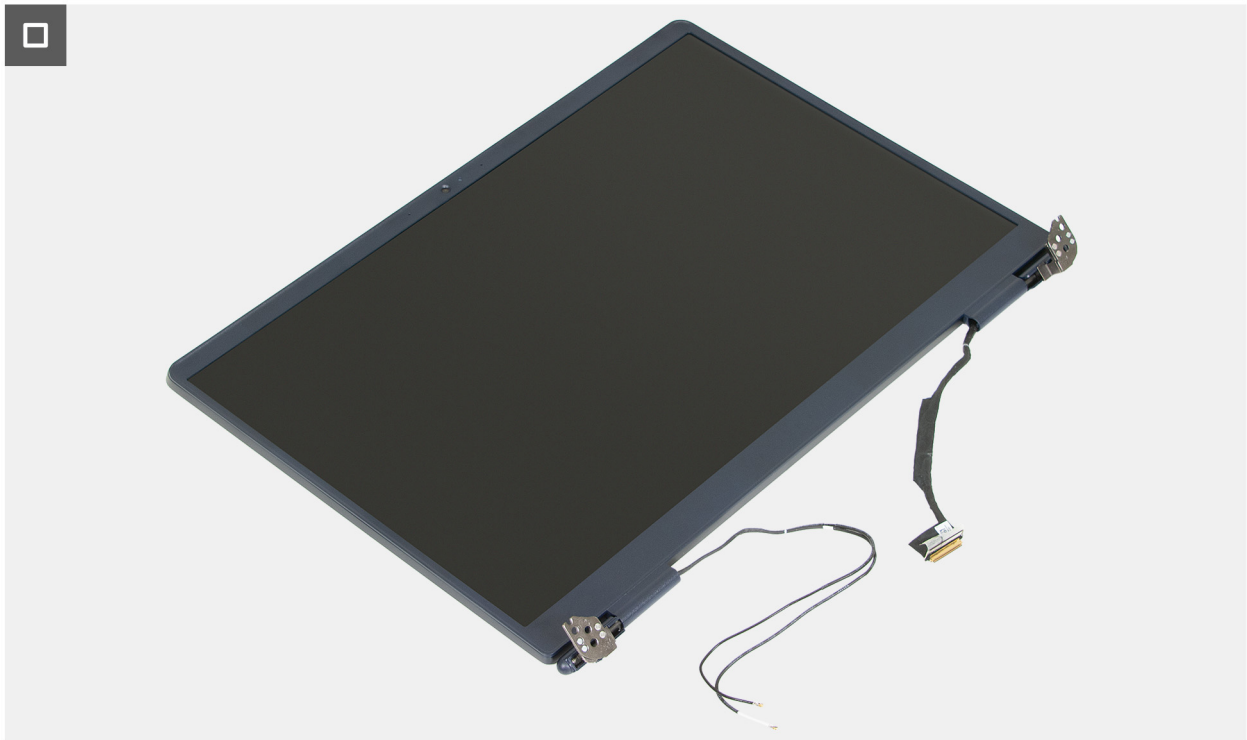

Figure 69. Display assembly

Installing the display assembly

CAUTION: The information in this installation section is intended for authorized service technicians only.

Prerequisites

If you are replacing a component, remove the existing component before performing the installation process.

About this task

The following images indicate the location of the display assembly and provide a visual representation of the installation procedure.



4x
M2.5x5

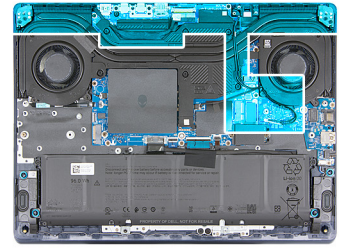

Figure 70. Installing the display assembly

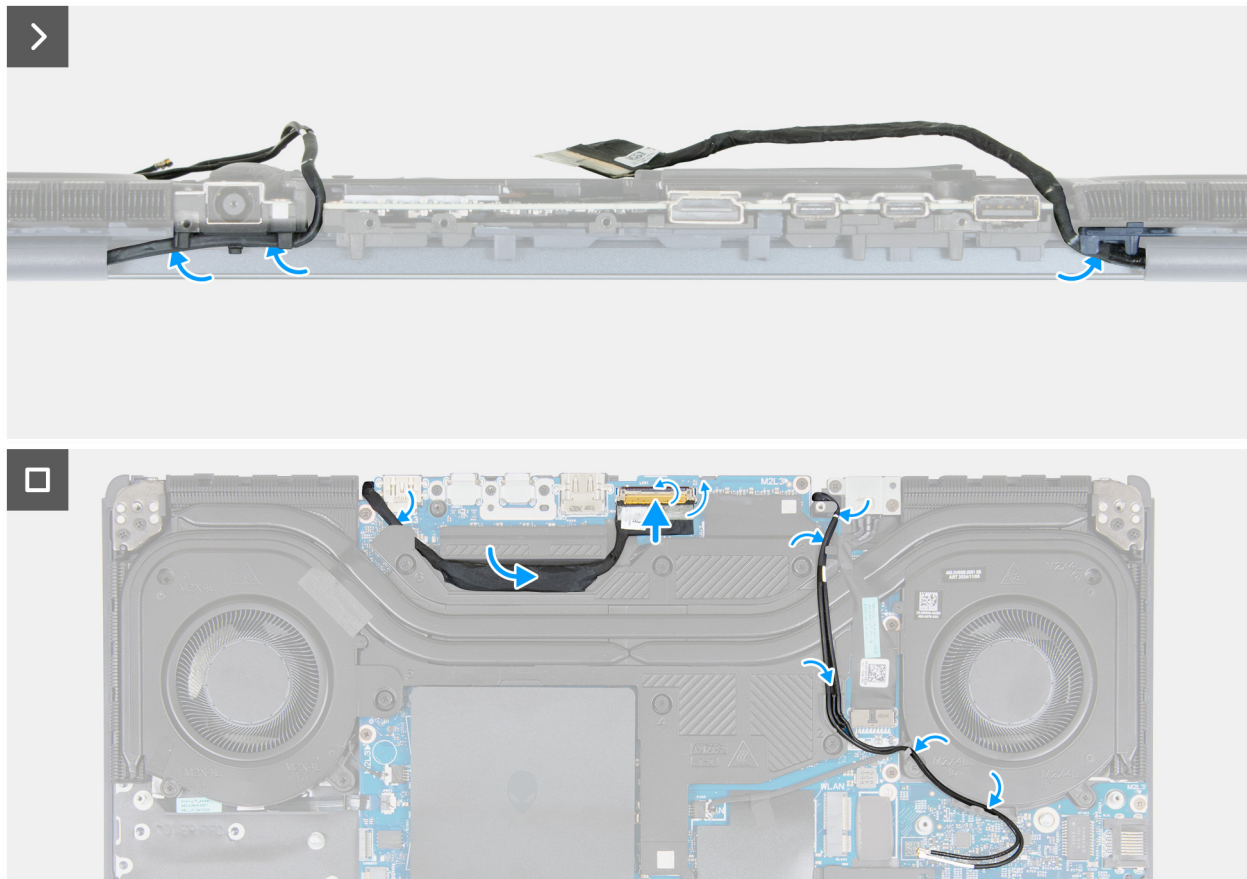

Figure 71. Installing the display assembly

Steps

1. Place the palm rest and keyboard assembly at the edge of a flat table.
2. Open the hinges of the display assembly to a 90-degree angle.
3. Align the screw holes on the display hinges with the screw holes on the palm rest and keyboard assembly.
4. Replace the four screws (M2.5x5) that secure the display hinges to the palm rest and keyboard assembly.
5. Close the display assembly and turn the computer to face the rear of the computer.
6. Route the antenna cables through the routing guides near the right hinge cover.
7. Route the display cable through the routing guides under the power adapter port.
8. Route the display cable through the routing guides on the fan and heat-sink assembly.
9. Route the antenna cables through the routing guides on the fan and heat-sink assembly.
10. Connect the display cable to the connector (LCD1) on the system board and close the latch to secure it.

Next steps

1. Install the [center bar](#).
2. Install the [rear cap](#).
3. Install the [wireless card](#).
4. Install the [base cover](#).
5. Follow the procedure in [After working inside your computer](#).

Palm rest and keyboard assembly

Removing the palm rest and keyboard assembly

CAUTION: The information in this removal section is intended for authorized service technicians only.

Prerequisites

1. Follow the procedure in [Before working inside your computer](#).
2. Remove the [base cover](#).
3. Remove the [battery](#).
4. Remove the [memory](#).
5. Remove the [solid state drive](#).
6. Remove the [wireless card](#).
7. Remove the [power-adapter port](#).
8. Remove the [Type-C bracket](#).
9. Remove the [system board](#).

NOTE: The system board can be removed as an assembly with the fan and heat-sink assembly to preserve the thermal bond between the system board and fan and heat-sink assembly.

10. Remove the [power button and power-button board](#).
11. Remove the [touchpad](#).
12. Remove the [display assembly](#).

About this task

The following images indicate the location of the palm rest and keyboard assembly and provide a visual representation of the removal procedure.

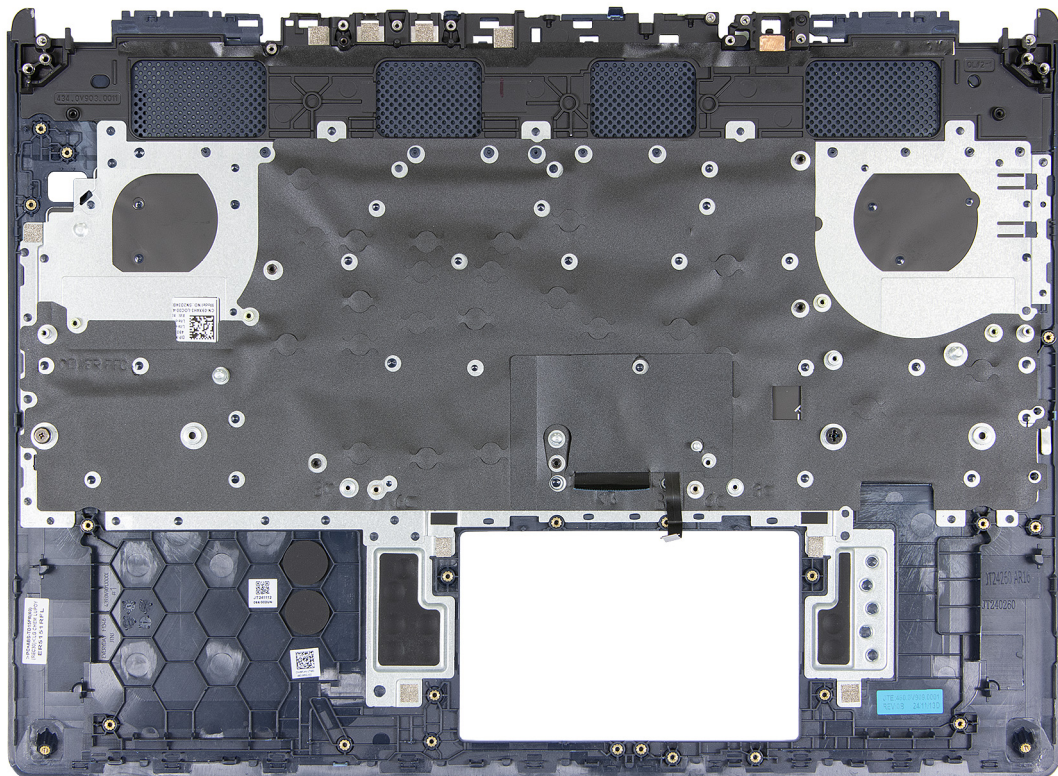

Figure 72. Removing the palm rest and keyboard assembly

Steps

After performing the pre-requisites, you are left with the palm rest and keyboard assembly.

NOTE: Ensure that the two solid state drive mounts are removed from the old palm rest and keyboard assembly before installing the new palm rest and keyboard assembly. These solid state drive mounts are to be installed onto the new palm rest and keyboard assembly.

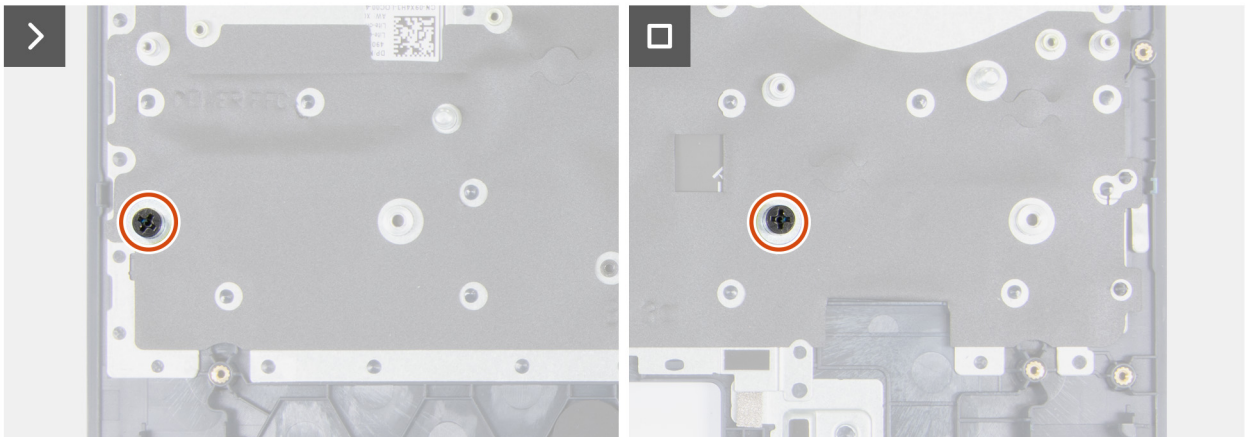
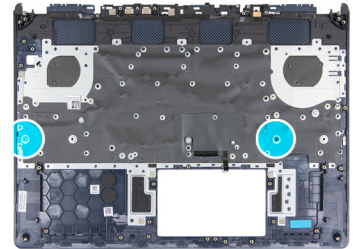

Figure 73. Removing SSD screw mounts

Installing the palm rest and keyboard assembly

CAUTION: The information in this installation section is intended for authorized service technicians only.

Prerequisites

If you are replacing a component, remove the existing component before performing the installation process.

About this task

The following images indicate the location of the palm rest and keyboard assembly and provide a visual representation of the installation procedure.



2x

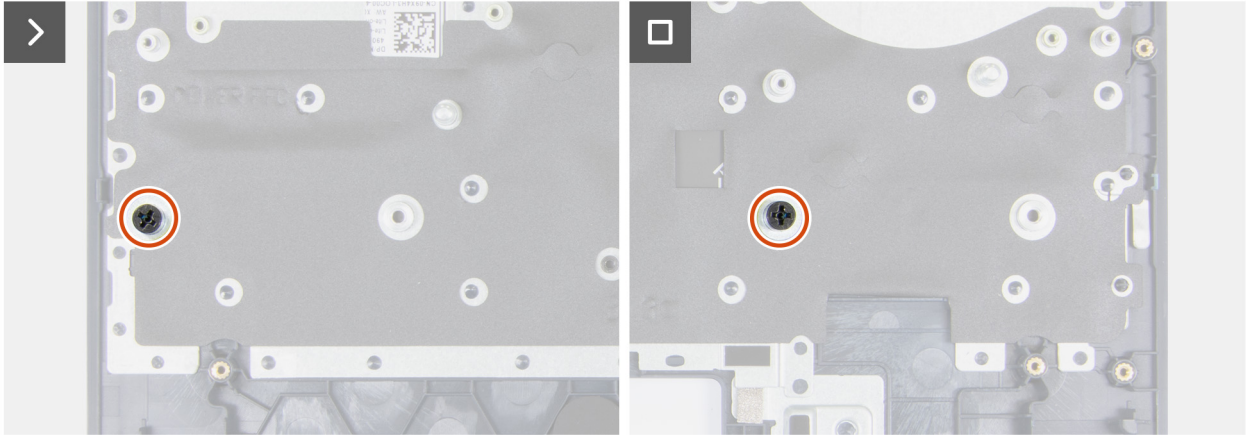
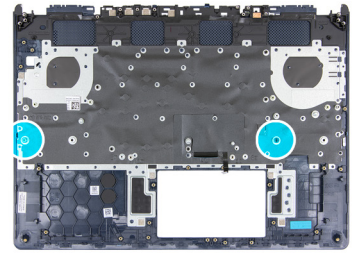

Figure 74. Installing the SSD screw mounts

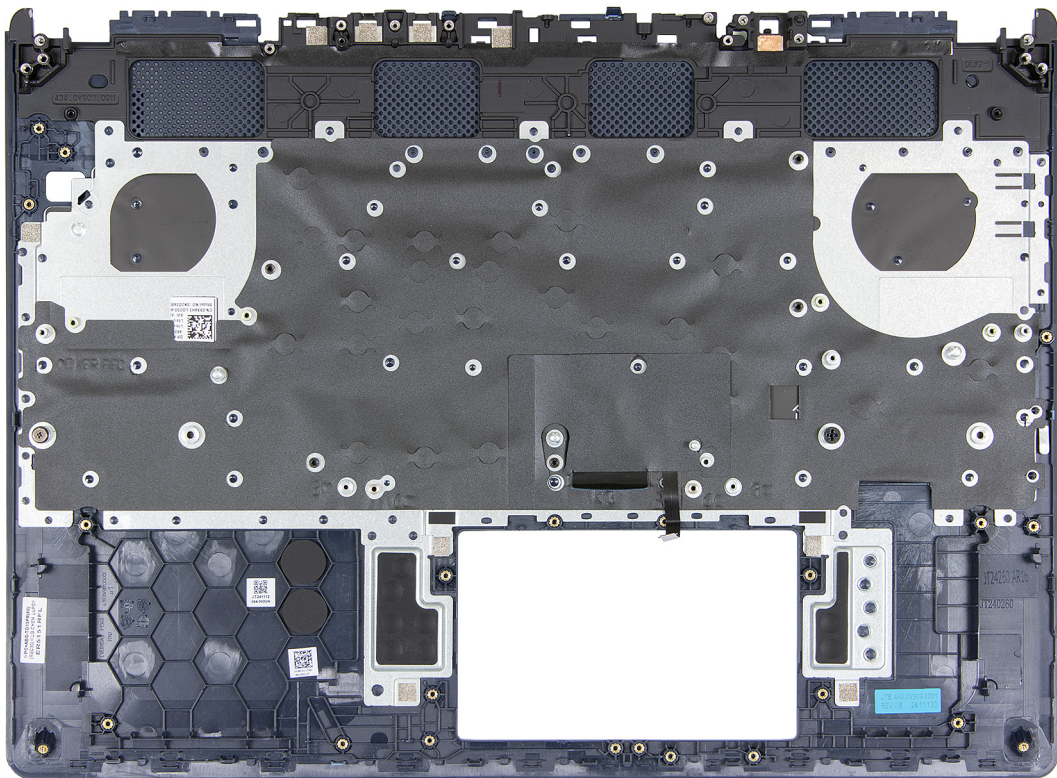



Figure 75. Installing the palm rest and keyboard assembly

Steps

1. Install the solid state drive mounts from the old palm rest and keyboard assembly onto the new palm rest and keyboard assembly.

2. Place the palm rest and keyboard assembly on a flat and clean surface and perform the post-requisites to install the palm rest and keyboard assembly.

 **NOTE:** Install the solid state drive mounts on the slots from the old palm rest and keyboard assembly onto the new palm rest and keyboard assembly.

Next steps

1. Install the [display assembly](#).
2. Install the [touchpad](#).
3. Install the [power button and power-button board](#).
4. Install the [system board](#).

 **NOTE:** The system board can be installed as an assembly with the fan and heat-sink assembly to preserve the thermal bond between the system board and fan and heat-sink assembly.

5. Install the [Type-C bracket](#).
6. Install the [power-adaptor port](#).
7. Install the [wireless card](#).
8. Install the [solid state drive](#).
9. Install the [memory](#).
10. Install the [battery](#).
11. Install the [base cover](#).
12. Follow the procedure in [After working inside your computer](#).

Software

This chapter details the supported operating systems along with instructions on how to install the drivers.

Operating system

Your Alienware 16 Aurora AC16250 supports the following operating systems:

- Windows 11 Home (64-bit)
- Windows 11 Professional (64-bit)
- Ubuntu Linux 24.04 LTS

Drivers and downloads

When troubleshooting, downloading, or installing drivers, it is recommended that you read the [Dell Knowledge Base article Drivers and Downloads FAQs](#).

BIOS Setup

CAUTION: Certain changes can make your computer work incorrectly. Before you change the settings in BIOS Setup, it is recommended that you note down the original settings for future reference.

NOTE: Depending on the computer and the installed devices, the options that are listed in this section may differ.

Use BIOS Setup for the following purposes:

- Get information about the hardware installed in your computer, such as the amount of RAM and the capacity of the storage device.
- Change the system configuration information.
- Set or change user-selectable options such as the user password, enabling or disabling base devices, and configuring hard drive settings.

Entering BIOS Setup program

Turn on or restart your computer and press F2 immediately.

Navigation keys

NOTE: For most of the BIOS Setup options, changes that you make are recorded but do not take effect until you restart the computer.

Table 28. Navigation keys

Keys	Navigation
Up arrow	Moves to the previous field.
Down arrow	Moves to the next field.
Enter	Selects a value in the selected field (if applicable) or follows the link in the field.
Spacebar	Expands or collapses a drop-down list, if applicable.
Tab	Moves to the next focus area.
Esc	Moves to the previous page until you view the main screen. Pressing Esc in the main screen displays a message that prompts you to save any unsaved changes and restart the computer.

F12 One Time Boot menu

To enter the One Time Boot menu, turn on or restart your computer, and then press F12 immediately.

NOTE: If you are unable to enter the One Time Boot menu, repeat the above action.

The One Time Boot menu displays the devices that you can boot from and also display the options to start diagnostics. The boot menu options are:

- Removable Drive (if available)
- STXXXX Drive (if available)

NOTE: XXX denotes the SATA drive number.

- Optical Drive (if available)
- SATA Hard Drive (if available)
- Diagnostics

The One Time Boot menu screen also displays the option to access BIOS Setup.

View Advanced Setup options

About this task

Some BIOS Setup options are only visible by enabling **Advanced Setup** mode, which is disabled by default.

NOTE: BIOS Setup options, including **Advanced Setup** options, are described in the **System setup options** section.

To enable Advanced Setup:

Steps

1. Enter BIOS Setup.
The Overview menu appears.
2. Click the **Advanced Setup** option to move it to the **ON** mode.
Advanced BIOS Setup options are displayed.

View Service options

About this task

Service options are hidden by default and only visible by entering a hotkey command.

NOTE: Service options are described in [BIOS Setup options](#).

To view Service options:

Steps

1. Enter BIOS Setup.
The Overview menu appears.
2. Enter the hotkey combination **Ctrl + Alt + s** to view the **Service** options.
Service options are displayed.

BIOS Setup options

NOTE: Depending on your computer and its installed devices, the items that are listed in this section may or may not be displayed.

Table 29. BIOS Setup options—Overview menu

Overview	
Alienware 16 Aurora AC16250	
BIOS Version	Displays the BIOS version number.
Service Tag	Displays the Service Tag of the computer.
Asset Tag	Displays the Asset Tag of the computer.
Manufacture Date	Displays the manufacture date of the computer.

Table 29. BIOS Setup options—Overview menu (continued)







Overview

Ownership Date	Displays the ownership date of the computer.
Express Service Code	Displays the Express Service Code of the computer.
Ownership Tag	Displays the Ownership Tag of the computer.
Signed Firmware Update	Displays whether the Signed Firmware Update is enabled on your computer. By default, the Signed Firmware Update option is enabled.  NOTE: To view this option, enable Service options as described in View Service options .

BATTERY

Primary	Displays the primary battery of the computer.
Battery Level	Displays the battery level of the computer.
Battery State	Displays the battery state of the computer.
Health	Displays the battery health of the computer.
AC Adapter	Displays whether an AC adapter is connected. If connected, displays the type of AC adapter that is connected.

PROCESSOR

Processor Type	Displays the processor type.
Maximum Clock Speed	Displays the maximum processor clock speed.
Minimum Clock Speed	Displays the minimum processor clock speed.  NOTE: To view this option, enable Service options as described in View Service options .
Current Clock Speed	Displays the current processor clock speed.  NOTE: To view this option, enable Service options as described in View Service options .
Core Count	Displays the number of cores on the processor.  NOTE: To view this option, enable Advanced Setup mode as described in View Advanced Setup options .
Processor ID	Displays the processor identification code.  NOTE: To view this option, enable Advanced Setup mode as described in View Advanced Setup options .
Processor L2 Cache	Displays the processor L2 Cache size.
Processor L3 Cache	Displays the processor L3 Cache size.
Microcode Version	Displays the microcode version.  NOTE: To view this option, enable Advanced Setup mode as described in View Advanced Setup options .
Intel Hyper-Threading Capable	Displays whether the processor is Hyper-Threading (HT) capable.  NOTE: To view this option, enable Advanced Setup mode as described in View Advanced Setup options .

MEMORY

Memory Installed	Displays the total computer memory installed.
Memory Available	Displays the total computer memory available.

Table 29. BIOS Setup options—Overview menu (continued)

Overview





	<p> NOTE: To view this option, enable Advanced Setup mode as described in View Advanced Setup options.</p>
Memory Speed	Displays the memory speed.
Memory Technology	<p>Displays the technology that is used for the memory.</p> <p> NOTE: To view this option, enable Advanced Setup mode as described in View Advanced Setup options.</p>
Memory Channel Mode	<p>Displays single or dual channel mode.</p> <p> NOTE: To view this option, enable Service options as described in View Service options.</p>
DIMM_SLOT 1	Displays the capacity of the memory module in slot 1.
DIMM_SLOT 2	Displays the capacity of the memory module in slot 2.
DEVICES	
Panel Type	Displays the panel type of the computer.
Panel Revision	Displays the panel revision number.
Video Controller	Displays the video controller type of the computer.
Video Memory	Displays the video memory information of the computer.
Wi-Fi Device	Displays the wireless device information of the computer.
Native Resolution	Displays the native resolution of the computer.
Video BIOS Version	<p>Displays the video BIOS version of the computer.</p> <p> NOTE: To view this option, enable Advanced Setup mode as described in View Advanced Setup options.</p>
Audio Controller	Displays the audio controller information of the computer.
Bluetooth Device	Displays the Bluetooth device information of the computer.
LOM MAC Address	Displays the LAN on motherboard MAC address of the computer.
dGPU Video Controller	Displays the video controller information of the computer.

Table 30. BIOS Setup options—Boot Configuration menu

Boot Configuration

Boot Sequence	
Boot Sequence	Displays the boot sequence.
Enable PXE Boot Priority	Enables or disables the addition of a newly detected PXE boot option to the boot sequence.
Secure Boot	
	<p>Secure Boot is a method of guaranteeing the integrity of the boot path by performing additional validation of the operating system and PCI add-in cards. The computer stops booting to the operating system when a component is not authenticated during the boot process. Secure Boot can be enabled in BIOS setup or using management interfaces like Dell Command Configure, but can only be disabled from BIOS setup.</p>
Enable Secure Boot	<p>Enables the computer to boot using only validated boot software.</p> <p>By default, the Enable Secure Boot option is enabled.</p> <p>For additional security, Dell Technologies recommends keeping the Secure Boot option enabled to ensure that the UEFI firmware validates the operating system during the boot process.</p>

Table 30. BIOS Setup options—Boot Configuration menu (continued)

Boot Configuration

	<p>i NOTE: For Secure Boot to be enabled, the computer is required to be in UEFI boot mode and the Enable Legacy Option ROMs option is required to be turned off.</p>
Enable Microsoft UEFI CA	<p>When disabled, the UEFI CA is removed from the BIOS UEFI Secure Boot database.</p> <p>i NOTE: When disabled, the Microsoft UEFI CA could render your computer unable to boot, computer graphics may not function, some devices may not function properly, and the computer could become unrecoverable.</p> <p>By default, the Enable Microsoft UEFI CA option is enabled.</p> <p>For additional security, Dell Technologies recommends keeping the Microsoft UEFI CA option enabled to ensure the broadest compatibility with devices and operating systems.</p>
Secure Boot Mode.	<p>Enables or disables the Secure Boot operation mode.</p> <p>By default, the Deployed Mode is selected.</p> <p>i NOTE: Deployed Mode should be selected for normal operation of Secure Boot.</p>
Expert Key Management	<p>i NOTE: To view this option, enable Advanced Setup mode as described in View Advanced Setup options.</p>
Enable Custom Mode	<p>Enables or disables the keys in the PK, KEK, db, and dbx security key databases to be modified.</p> <p>By default, the Enable Custom Mode option is disabled.</p>
Custom Mode Key Management	<p>Selects the custom values for expert key management.</p> <p>By default, the PK option is selected.</p>

Table 31. BIOS Setup options—Integrated Devices menu

Integrated Devices

Date/Time	
Date	Sets the computer date in MM/DD/YYYY format. Changes to the date format take effect immediately.
Time	Sets the computer time in HH/MM/SS 24-hour format. You can switch between a 12-hour and 24-hour clock. Changes to the time format take effect immediately.
Camera	
Enable Camera	<p>Enables the camera.</p> <p>By default, the Enable Camera option is enabled.</p> <p>i NOTE: Depending on the configuration ordered, the camera setup option may not be available.</p>
Audio	
Enable Audio	<p>Enables all integrated audio controller.</p> <p>By default, all the Enable Audio option is enabled.</p>
Enable Microphone	<p>Enables the microphone.</p> <p>By default, the Enable Microphone option is enabled.</p> <p>i NOTE: Depending on the configuration ordered, the microphone setup option may not be available.</p>

Table 31. BIOS Setup options—Integrated Devices menu (continued)

Integrated Devices

Enable Internal Speaker	Enables the internal speaker. By default, the Enable Internal Speaker option is enabled.
-------------------------	--

USB/Thunderbolt Configuration

Enable External USB Ports	Enables the external USB ports. By default, the Enable External USB Ports option is enabled. i NOTE: To view this option, enable Advanced Setup mode as described in View Advanced Setup options .
Enable USB Boot Support	Enables booting from USB mass storage devices that are connected to external USB ports. By default, the Enable USB Boot Support option is enabled.

Table 32. BIOS Setup options—Storage menu

Storage

SATA/NVMe Operation	i NOTE: To view this option, enable Advanced Setup mode as described in View Advanced Setup options .
SATA/NVMe Operation	Sets the operating mode of the storage device. By default, the RAID On option is selected. The storage device is configured for RAID mode.
SMART Reporting	i NOTE: To view this option, enable Advanced Setup mode as described in View Advanced Setup options .
Enable SMART Reporting	Enables or disables the reporting of hard drive errors for integrated drives during startup. By default, the Enable SMART Reporting option is disabled.
Drive Information	Displays the information of onboard drives.

Table 33. BIOS Setup options—Display menu

Display

i **NOTE:** To view the Display menu options, enable **Advanced Setup** mode as described in [View Advanced Setup options](#).

Display Brightness

Brightness on battery power	Enables to set the screen brightness when the computer is running on battery power. By default, the screen brightness is set to 50 when the computer is running on battery power.
Brightness on AC power	Enables to set the screen brightness when the computer is running on AC power. By default, the screen brightness is set to 100 when the computer is running on AC power.

Full Screen Logo

Full Screen Logo	Enables or disables the computer to display a full-screen logo, if the image matches screen resolution. By default, the Full Screen Logo option is disabled.
------------------	--

Hybrid Graphics

Enable Hybrid Graphics	Enables or disables the ability of both integrated and discrete graphics controller working together for optimized capability and batter life. By default, the Enable Hybrid Graphics option is enabled.
------------------------	--

Table 34. BIOS Setup options—Connection menu





Connection	
Network Controller Configuration	 NOTE: To view this option, enable Advanced Setup mode as described in View Advanced Setup options .
Integrated NIC	Sets the option controls on the onboard LAN controller. By default, the Enabled with PxE option is selected.
Wireless Device Enable	
WLAN/WiGig	Enables or disables the internal WLAN device. By default, the WLAN/WiGig option is enabled.
Bluetooth	Enables or disables the internal Bluetooth device. By default, the Bluetooth option is enabled.  NOTE: To view this option, enable Advanced Setup mode as described in View Advanced Setup options .
Enable UEFI Network Stack	 NOTE: To view this option, enable Advanced Setup mode as described in View Advanced Setup options .
Enable UEFI Network Stack	Enables or disables the UEFI Network Stack and controls the onboard LAN Controller. By default, the Auto Enabled option is enabled.
HTTP(s) Boot Feature	 NOTE: To view this option, enable Advanced Setup mode as described in View Advanced Setup options .
HTTP(s) Boot	Enables or disables HTTP(s) Boot capabilities. By default, the option is enabled.
HTTP(s) Boot Modes	Sets the method on how to read the Boot URL. By default, the Auto Mode option is enabled.

Table 35. BIOS Setup options—Power menu



Power	
Battery Configuration	 NOTE: To view this option, enable Advanced Setup mode as described in View Advanced Setup options .
Battery Configuration	Enables or disables the computer to run on battery during peak power usage hours. Use the table Custom Charge Start and Custom Charge Stop , to prevent AC power usage between certain times of each day. By default, the Adaptive option is selected. Battery settings are adaptively optimized based on your typical battery usage pattern.
Advanced Configuration	 NOTE: To view this option, enable Advanced Setup mode as described in View Advanced Setup options .
Enable Advanced Battery Charge Configuration	Enables Advanced Battery Charge Configuration from the beginning of the day to a specified work period. When enabled, Advanced Battery Charged maximizes battery health while still supporting heavy use during the work day. By default, the Enable Advanced Battery Charge Configuration option is disabled.
Thermal Management	 NOTE: To view this option, enable Advanced Setup mode as described in View Advanced Setup options .
Thermal Management	Enables or disables cooling of fan and manages processor heat to adjust the computer performance, noise, and temperature.

Table 35. BIOS Setup options—Power menu (continued)

Power	
	By default, the Optimized option is selected. Standard setting for balanced performance, noise, and temperature.
USB Wake Support	i NOTE: To view this option, enable Advanced Setup mode as described in View Advanced Setup options .
Wake on Dell USB-C Dock	When enabled, connecting a Dell USB-C Dock wakes the computer from Standby, Hibernate, and Power Off. By default, the Wake on Dell USB-C Dock option is enabled.
Block Sleep	i NOTE: To view this option, enable Advanced Setup mode as described in View Advanced Setup options .
Block Sleep	Enables or disables the computer from entering Sleep (S3) mode in the operating system. i NOTE: When enabled, the computer does not go to Sleep, Intel Rapid Start is disabled automatically, and the operating system power option is blank if it was set to Sleep. By default, the Block Sleep option is disabled.
Lid Switch	
Enable Lid Switch	Enables or disables the Lid Switch. By default, the Enable Lid Switch option is enabled.
Power On Lid Open	When enabled, it allows the computer to turn on from the off state whenever the lid is opened. By default, the Power On Lid Open option is enabled.
Intel Speed Shift Technology	Enables or disables the Intel Speed Shift Technology support. When enabled, the operating system selects the appropriate processor performance automatically. By default, the Intel Speed Shift Technology option is enabled. i NOTE: To view this option, enable Service options as described in View Service options .

Table 36. BIOS Setup options—Security menu

Security	
Intel Platform Trust Technology	i NOTE: To view this option, enable Advanced Setup mode as described in View Advanced Setup options . Intel PTT is a firmware-based Trusted Platform Module (fTPM) device that is part of Intel chipsets. It provides credential storage and key management that can replace the equivalent functionality of a discrete TPM chip. i NOTE: The options that are listed apply to computers with a discrete Trusted Platform Module (TPM) .
Intel Platform Trust Technology On	Enables or disables the Intel Platform Trust Technology On option. By default, the Platform Trust Technology On option is enabled. For additional security, Dell Technologies recommends keeping the Platform Trust Technology On option enabled.
Physical Presence Interface (PPI) Bypass for Clear Commands	The PPI Bypass for Clear Commands option allows the operating system to manage certain aspects of PTT. When enabled, you are not prompted to confirm changes to the PTT configuration. By default, the PPI Bypass for Clear Commands option is disabled.

Table 36. BIOS Setup options—Security menu (continued)







Security	
	For additional security, Dell Technologies recommends keeping the PPI Bypass for Clear Commands option disabled.
Clear	<p>When enabled, the Clear option clears the information that is stored in the PTT fTPM after exiting the computer's BIOS. This option returns to the disabled state when the computer restarts.</p> <p>By default, the Clear option is disabled.</p> <p>Dell Technologies recommends enabling the Clear option only when PTT fTPM data needs to be cleared.</p>
SMM Security Mitigation	<p>Enables or disables additional UEFI SMM Security Mitigation protections. This option uses the Windows SMM Security Mitigations Table (WSMT) to confirm to the operating system that security best practices have been implemented by the UEFI firmware.</p> <p>By default, the SMM Security Mitigation option is enabled.</p> <p>For additional security, Dell Technologies recommends keeping the SMM Security Mitigation option enabled unless you have a specific application which is not compatible.</p> <p> NOTE: This feature may cause compatibility issues or loss of functionality with some legacy tools and applications.</p> <p> NOTE: To view this option, enable Service options as described in View Service options.</p>
Data Wipe on Next Boot	<p> NOTE: To view this option, enable Advanced Setup mode as described in View Advanced Setup options.</p>
Start Data Wipe	<p>Data Wipe is a secure wipe operation that deletes information from a storage device.</p> <p> CAUTION: The secure Data Wipe operation deletes information in a way that it cannot be reconstructed.</p> <p>Commands such as delete and format in the operating system may remove files from showing up in the file system. However, they can be reconstructed through forensic means as they are still represented on the physical media. Data Wipe prevents this reconstruction and is not recoverable.</p> <p>When enabled, the data wipe option will prompt to wipe any storage devices that are connected to the computer on the next boot.</p> <p>By default, the Start Data Wipe option is disabled.</p>
Absolute	<p>Absolute Software provides various cyber security solutions, some requiring software preloaded on Dell computers and integrated into the BIOS. To use these features, you must enable the Absolute BIOS setting and contact Absolute for configuration and activation.</p> <p>By default, the Absolute option is enabled.</p> <p>For additional security, Dell Technologies recommends keeping the Absolute option enabled.</p> <p> NOTE: When the Absolute features are activated, the Absolute integration cannot be disabled from the BIOS setup screen.</p>
UEFI Boot Path Security	<p> NOTE: To view this option, enable Advanced Setup mode as described in View Advanced Setup options.</p>
UEFI Boot Path Security	<p>Enables or disables the computer to prompt the user to enter the Administrator password (if set) when booting to a UEFI boot path device from the F12 boot menu.</p> <p>By default, the Always Except Internal HDD option is enabled.</p>
Firmware Device Tamper Detection	<p>Allows you to control the firmware device tamper detection feature. This feature notifies the user when the firmware device is tampered. When enabled, a screen warning messages are displayed on the computer and a tamper detection event is logged in the BIOS Events log. The computer fails to reboot until the event is cleared.</p>

Table 36. BIOS Setup options—Security menu (continued)

Security

By default, the **Firmware Device Tamper Detection** option is silent.
For additional security, Dell Technologies recommends keeping the **Firmware Device Tamper Detection** option enabled.

Clear Firmware Device Tamper Detection

Enables or disables the option to clear the event.
By default, the **Clear Firmware Device Tamper Detection** option is disabled.

Table 37. BIOS Setup options—Passwords menu

Passwords

Admin Password

The Administrator Password prevents unauthorized access to the BIOS Setup options. Once the administrator password is set, the BIOS setup options can only be modified after providing the correct password.

The following rules and dependencies apply to the Administrator Password -

- The administrator password cannot be set if the computer and/or internal storage passwords are previously set.
- The administrator password can be used in place of the computer and/or internal storage passwords.
- When set, the administrator password must be provided during a firmware update.
- Clearing the administrator password also clears the computer password (if set).

Dell Technologies recommends using an administrator password to prevent unauthorized changes to BIOS setup options.

System Password

The System Password prevents the computer from booting to an operating system without entering the correct password.

The following rules and dependencies apply when the System Password is used -

- The computer shuts down when idle for approximately 10 minutes at the computer password prompt.
- The computer shuts down after three incorrect attempts to enter the computer password.
- The computer shuts down when the **Esc** key is pressed at the System Password prompt.
- The computer password is not prompted when the computer resumes from standby mode.

Dell Technologies recommends using the computer password in situations where it is likely that a computer may be lost or stolen.

M.2 PCIe SSD-1

The M.2 PCIe SSD password can be set to prevent unauthorized access of the data stored on the solid state drive. The computer prompts for the solid state drive password during boot in order to unlock the drive. A password-secured solid state drive stays locked even when removed from the computer or placed into another computer. It prevents an attacker from accessing data on the drive without authorization.

The following rules and dependencies apply when this option is used:

- The solid state drive password option cannot be accessed when a solid state drive is disabled in the BIOS setup.
 - The computer shuts down when idle for approximately 10 minutes at the solid state drive password prompt.
 - The computer shuts down after three incorrect attempts to enter the solid state drive password and treats the solid state drive as not available.
 - The solid state drive does not accept password unlock attempts after five incorrect attempts to enter the solid state drive password from the BIOS Setup. The solid state drive password must be reset for the new password unlock attempts.
 - The computer treats the solid state drive as not available when the **Esc** key is pressed at the solid state drive password prompt.
-

Table 37. BIOS Setup options—Passwords menu (continued)

Passwords	
	<ul style="list-style-type: none"> The solid state drive password is not prompted when the computer resumes from standby mode. When the solid state drive is unlocked by the user before the computer goes into standby mode, it remains unlocked after the computer resumes from standby mode. If the computer and solid state drive passwords are set to the same value, the solid state drive unlocks after the correct computer password is entered. <p>Dell Technologies recommends using a solid state drive password to protect unauthorized data access.</p>
Password Configuration	<p>The Password configuration page includes several options for changing the requirements of BIOS passwords. You can modify the minimum and maximum length of the passwords and require passwords to contain certain character classes (upper case, lower case, digit, special character).</p> <p>NOTE: To view this option, enable Advanced Setup mode as described in View Advanced Setup options.</p> <p>Dell Technologies recommends setting the minimum password length to at least eight characters.</p>
Password Bypass	<p>The Password Bypass option allows the computer to reboot from the operating system without entering the computer or hard drive password. If the computer has already booted to the operating system, it is presumed that the user has already entered the correct computer or hard drive password.</p> <p>NOTE: This option does not remove the requirement to enter the password after shutting down.</p> <p>By default, the Password Bypass option is disabled.</p> <p>NOTE: To view this option, enable Advanced Setup mode as described in View Advanced Setup options.</p> <p>For additional security, Dell Technologies recommends keeping the Password Bypass option disabled.</p>
Password Changes	<p>NOTE: To view this option, enable Advanced Setup mode as described in View Advanced Setup options.</p>
Allow Non-Admin Password Changes	<p>The Allow Non-Admin Password Changes option in BIOS setup allows an end user to set or change the computer or hard drive passwords without entering the administrator password. This gives an administrator control over the BIOS settings but enables an end user to provide their own password.</p> <p>By default, the Allow Non-Admin Password Changes option is enabled.</p> <p>For additional security, Dell Technologies recommends keeping the Allow Non-Admin Password Changes option disabled.</p>
Admin Setup Lockout	<p>NOTE: To view this option, enable Advanced Setup mode as described in View Advanced Setup options.</p>
Enable Admin Setup Lockout	<p>The Enable Admin Setup Lockout option prevents an end user from even viewing the BIOS setup configuration without first entering the administrator password (if set).</p> <p>By default, the Enable Admin Setup Lockout option is disabled.</p> <p>For additional security, Dell Technologies recommends keeping the Enable Admin Setup Lockout option disabled.</p>
Master Password Lockout	<p>NOTE: To view this option, enable Advanced Setup mode as described in View Advanced Setup options.</p>
Enable Master Password Lockout	<p>The Master Password Lockout setting allows you to disable the Recovery Password feature. If the computer, administrator, or hard drive password is forgotten, the computer becomes unusable.</p>

Table 37. BIOS Setup options—Passwords menu (continued)

Passwords	
	<p>NOTE: When the owner password is set, the Master Password Lockout option is not available.</p> <p>When an internal hard drive password is set, it must first be cleared before Master Password Lockout can be changed.</p> <p>By default, the Enable Master Password Lockout option is disabled.</p> <p>Dell does not recommend enabling the Master Password Lockout unless you have implemented your own password recovery computer.</p>
Allow Non-Admin PSID Revert	<p>NOTE: To view this option, enable Advanced Setup mode as described in View Advanced Setup options.</p>
Enable Allow Non-Admin PSID Revert	<p>The Allow Non-Admin Password Changes option in BIOS setup allows an end user to set or change the computer or hard drive passwords without entering the administrator password. This gives an administrator control over the BIOS settings but enables an end user to provide their own password.</p> <p>By default, the Allow Non-Admin Password Changes option is disabled.</p> <p>For additional security, Dell Technologies recommends keeping the Allow Non-Admin Password Changes option disabled.</p>

Table 38. BIOS Setup options—Update, Recovery menu

Update, Recovery	
UEFI Capsule Firmware Updates	<p>NOTE: To view this option, enable Service options as described in View Service options.</p>
Enable UEFI Capsule Firmware Updates	<p>Enables or disables BIOS updates through UEFI capsule update packages.</p> <p>NOTE: Disabling this option blocks the BIOS updates from services such as Microsoft Windows Update and Linux Vendor Firmware Service (LVFS).</p> <p>By default, the Enable UEFI Capsule Firmware Updates option is enabled.</p>
BIOS Recovery from Hard Drive	<p>NOTE: To view this option, enable Advanced Setup mode as described in View Advanced Setup options.</p>
BIOS Recovery from Hard Drive	<p>Enables or disables the user to recover from certain corrupted BIOS conditions from a recovery file on the user primary hard drive or an external USB drive.</p> <p>By default, the BIOS Recovery from Hard Drive option is enabled.</p> <p>NOTE: BIOS Recovery from Hard Drive is not available for self-encrypting drives (SED).</p> <p>NOTE: BIOS recovery is designed to fix the main BIOS block and cannot work if the Boot Block is damaged. In addition, this feature cannot work in the event of EC corruption, ME corruption, or a hardware issue. The recovery image must exist on an unencrypted partition on the drive.</p>
BIOS Downgrade	<p>NOTE: To view this option, enable Advanced Setup mode as described in View Advanced Setup options.</p>
Allow BIOS Downgrade	<p>Controls flashing of the computer firmware to previous revisions.</p> <p>By default, the Allow BIOS Downgrade option is enabled.</p>
SupportAssist OS Recovery	<p>Enables or disables the boot flow for SupportAssist OS Recovery tool if certain computer errors.</p> <p>By default, the SupportAssist OS Recovery option is enabled.</p>
BIOSConnect	<p>Enables or disables cloud Service operating system recovery if the main operating system fails to boot with the number of failures equal to or greater than the value specified by</p>

Table 38. BIOS Setup options—Update, Recovery menu (continued)

Update, Recovery	
	<p>the Auto operating system Recovery Threshold setup option and the local Service operating system does not boot or is not installed.</p> <p>By default, the BIOSConnect option is enabled.</p>
Dell Auto OS Recovery Threshold	<p>Allows you to control the automatic boot flow for SupportAssist System Resolution Console and for Dell Operating System Recovery Tool.</p> <p>By default, the Dell Auto OS Recovery Threshold value is set to 2.</p>

Table 39. BIOS Setup options—System Management menu





System Management	
Service Tag	Displays the Service Tag of the computer.
Asset Tag	<p>Creates a computer Asset Tag that can be used by an IT administrator to uniquely identify a particular computer.</p> <p> NOTE: Once set in the BIOS setup menu, the Asset Tag cannot be changed.</p>
AC Behavior	
Wake on LAN	<p>Enables or disables the computer to turn on by a special LAN signal.</p> <p>By default, the Wake on LAN option is disabled.</p> <p> NOTE: To view this option, enable Advanced Setup mode as described in View Advanced Setup options.</p>
Auto On Time	<p>Enable to set the computer to turn on automatically every day or on a preselected date and time. This option can be configured only if the Auto On Time is set to Everyday, Weekdays, or Selected Days.</p> <p>By default, the Auto On Time option is disabled.</p> <p> NOTE: To view this option, enable Advanced Setup mode as described in View Advanced Setup options.</p>
First Power On Date	
Set Ownership Date	<p>Enables or disables the option for Set Ownership Date.</p> <p>By default, the Set Ownership Date option is disabled.</p>
Diagnostics	 NOTE: To view this option, enable Advanced Setup mode as described in View Advanced Setup options .
OS Agent Requests	<p>Enable or disable the scheduling of onboard diagnostics.</p> <p>By default, the OS Agent Requests option is enabled.</p>
Power-on-Self-Test Automatic Recovery	 NOTE: To view this option, enable Advanced Setup mode as described in View Advanced Setup options .
Power-on-Self-Test Automatic Recovery	<p>Enable or disable the automatic BIOS recovery if the computer becomes unresponsive before completing POST.</p> <p>By default, the Power-on-Self-Test Automatic Recovery option is enabled.</p>

Table 40. BIOS Setup options—Keyboard menu

Keyboard	
Numlock Enable	
Enable Numlock	Enables or disables the Numlock function when the computer boots. By default, the Enable Numlock option is enabled.

Table 40. BIOS Setup options—Keyboard menu (continued)

Keyboard	
Fn Lock Options	 NOTE: To view this option, enable Advanced Setup mode as described in View Advanced Setup options .
Fn Lock Options	Enables or disables the Fn Lock option. By default, the Fn Lock Options is enabled.
Lock Mode	By default, the Lock Mode Secondary option is enabled. With this option, the F1-F12 keys scan the code for their secondary functions.
Keyboard Illumination	Configures the operating mode of the keyboard illumination feature. By default, the Bright option is selected. Enables the keyboard illumination feature at 100% brightness level.
Keyboard Backlight Timeout on AC	Sets the timeout value for the keyboard backlight when an AC adapter is connected to the computer. By default, the 1 minute option is selected.
Keyboard Backlight Timeout on Battery	Sets the timeout value for the keyboard backlight when the computer is running only on the battery power. The keyboard backlight timeout value is only effective when the backlight is enabled. By default, the 1 minute option is selected.

Table 41. BIOS Setup options—Pre-boot Behavior menu



Preboot Behavior	
Adapter Warnings	
Enable Adapter Warnings	Enables the warning messages during boot when the adapters with less power capacity are detected. By default, the Enable Adapter Warnings option is enabled.
Warnings and Errors	Enables or disables the action to be taken when a warning or error is encountered. By default, the Prompt on Warnings and Errors option is selected. Stop, prompt, and wait for user input when warnings or errors are detected.  NOTE: Errors deemed critical to the operation of the computer hardware stop the functioning of the computer.
USB-C Warnings	
Enable Dock Warning Messages	Enables the warning messages during boot when the USB-C adapters with less power capacity are detected. By default, the Enable Dock Warning Messages option is enabled.
Extend BIOS POST Time	 NOTE: To view this option, enable Advanced Setup mode as described in View Advanced Setup options .
Extend BIOS POST Time	Sets the BIOS POST (Power-On Self-Test) load time. By default, the 0 seconds option is selected.
Sign of Life	 NOTE: To view this option, enable Advanced Setup mode as described in View Advanced Setup options .
Early Keyboard Backlight	Keyboard Backlight Sign of Life. By default, the Early Keyboard Backlight option is enabled.
Show Ownership Tag with Logo	Enables the display of the Ownership Tag in addition to the BIOS Boot logo. This option is available only if an Ownership Tag has been set.

Table 41. BIOS Setup options—Pre-boot Behavior menu (continued)

Preboot Behavior

By default, the **Show Ownership Tag with Logo** option is disabled.

NOTE: To view this option, enable **Advanced Setup** mode as described in [View Advanced Setup options](#).

Table 42. BIOS Setup options—Virtualization Support menu

Virtualization Support

NOTE: To view this Virtualization Support menu options, enable **Advanced Setup** mode as described in [View Advanced Setup options](#).

Intel Virtualization Technology

NOTE: To view this option, enable **Service** options as described in [View Service options](#).

Enable Intel Virtualization Technology (VT)

When enabled, the computer can run a Virtual Machine Monitor (VMM).

By default, the **Enable Intel Virtualization Technology (VT)** option is enabled.

VT for Direct I/O

NOTE: To view this option, enable **Service** options as described in [View Service options](#).

Enable Intel VT for Direct I/O

When enabled, the computer can perform Virtualization Technology for Direct I/O (VT-d). VT-d is an Intel method that provides virtualization for memory map I/O.

By default, the **Enable Intel VT for Direct I/O** option is enabled.

DMA Protection

NOTE: To view this option, enable **Advanced Setup** mode as described in [View Advanced Setup options](#).

Enable Pre-Boot DMA Support

Allows you to control the Pre-Boot DMA protection for both internal and external ports. This option does not directly enable DMA protection in the operating system.

NOTE: This option is not available when the virtualization setting for IOMMU is disabled (VT-d/AMD Vi).

By default, the **Enable Pre-Boot DMA Support** option is enabled. For additional security, Dell Technologies recommends keeping the **Enable Pre-Boot DMA Support** option enabled.

NOTE: This option is provided only for compatibility purposes, since some older hardware is not DMA capable.

Enable OS Kernel DMA Support

Allows you to control the Kernel DMA protection for both internal and external ports. This option does not directly enable DMA protection in the operating system. For operating systems that support DMA protection, this setting indicates to the operating system that the BIOS supports the feature.

NOTE: This option is not available when the virtualization setting for IOMMU is disabled (VT-d/AMD Vi).

By default, the **Enable OS Kernel DMA Support** option is enabled.

NOTE: This option is provided only for compatibility purposes, since some older hardware is not DMA capable.

Internal Port DMA Compatibility Mode

Enables the BIOS to notify the operating system that internal ports are not DMA-capable.

By default, the **Internal Port DMA Compatibility Mode** option is disabled.

Table 43. BIOS Setup options—Performance menu

Performance

NOTE: To view the Performance menu options, enable **Advanced Setup** mode as described in [View Advanced Setup options](#).

Multi-Core Support

NOTE: To view this option, enable **Service** options as described in [View Service options](#).

Table 43. BIOS Setup options—Performance menu (continued)







Performance	 NOTE: To view the Performance menu options, enable Advanced Setup mode as described in View Advanced Setup options .
Active Multiple Performance Cores (P-Cores) Select	Allows to change the number of CPU cores available to the operating system. The default value is set to the maximum number of cores. By default, the All Active option is selected.
Active Efficient Core (E-Cores) Select	Allows to change the number of CPU E-cores available to the operating system. The default value is set to the maximum number of cores. By default, the All Active option is selected.
Intel SpeedStep	
Enable Intel SpeedStep Technology	Enables the computer to dynamically adjust processor voltage and core frequency, decreasing average power consumption and heat production. By default, the Enable Intel SpeedStep Technology option is enabled.
C-State Control	 NOTE: To view this option, enable Service options as described in View Service options .
Enable C-State Control	Enables or disables the ability of the CPU to enter and exit low-power state. When disabled, it disables all C-states. When enabled, it enables all C-states that the chipset or platform allows. By default, the Enable C-State Control option is enabled.
Enable Adaptive C-States for Discrete Graphics	Enables or disables the ability of the computer to dynamically detect high-usage of discrete graphics and adjust system parameters for higher performance during the time to enter and exit low-power state. When disabled, it disables all C-states. When enabled, it enables all C-states that the chipset or platform allows. By default, the Enable Adaptive C-States for Discrete Graphics is enabled.
Intel Turbo Boost Technology	 NOTE: To view this option, enable Service options as described in View Service options .
Enable Intel Turbo Boost Technology	Enables or disables the Intel TurboBoost mode of the processor. When enabled, the Intel TurboBoost driver increases the performance of the CPU or graphics processor. By default, the Enable Intel Turbo Boost Technology option is enabled.
Intel Turbo Boost Maximum Technology 3.0	 NOTE: To view this option, enable Advanced Setup mode as described in View Advanced Setup options .
Intel Turbo Boost Maximum Technology 3.0	Enables or disables the ability of the processor running a high workload to perform at a higher frequency than the maximum turbo frequency of the processor. By default, the Intel Turbo Boost Maximum Technology 3.0 option is enabled.
Intel Hyper-Threading Technology	 NOTE: To view this option, enable Advanced Setup mode as described in View Advanced Setup options .
Enable Intel Hyper-Threading Technology	Enables or disables the Intel Hyper-Threading mode of the processor. When enabled, the Intel Hyper-Threading increases the efficiency of the processor resources when multiple threads run on each core. By default, the Intel Hyper-Threading Technology option is enabled.
OverClocking feature	 NOTE: To view this option, enable Advanced Setup mode as described in View Advanced Setup options .
OverClocking feature	Enables global overclocking functions. By default, the Overclocking feature option is disabled.

Table 43. BIOS Setup options—Performance menu (continued)

Performance

 **NOTE:** To view the Performance menu options, enable **Advanced Setup** mode as described in [View Advanced Setup options](#).

Core OverClocking Level #	When this option is enabled, it allows the processor to adjust the Flex Ratio and Voltage in a Turbo Mode environment.
TCC Activation Offset	Allows you to adjust the CPU's Tcc offset. By default, the TCC Activation Offset is set to 00.

Table 44. BIOS Setup options—System Logs menu

System Logs

BIOS Event Log

Clear BIOS Event Log	Allows you to select option to keep or clear BIOS events logs. By default, the Keep Log option is selected.
----------------------	---

Thermal Event Log

Clear Thermal Event Log	Allows you to select option to keep or clear Thermal events logs. By default, the Keep Log option is selected.
-------------------------	--

Power Event Log

Clear Power Event Log	Allows you to select option to keep or clear Power events logs. By default, the Keep Log option is selected.
-----------------------	--

Updating the BIOS

Updating the BIOS in Windows

About this task

 **CAUTION:** If BitLocker is not suspended before updating the BIOS, the BitLocker key is not recognized the next time you reboot the computer. You will then be prompted to enter the recovery key to proceed, and the computer displays a prompt for the recovery key on each reboot. Failure to provide the recovery key can result in data loss or an operating system reinstall. For more information, see the Knowledge Base Resource [Updating the BIOS on Dell systems with BitLocker enabled](#).

 **CAUTION:** Do not turn off the computer during the BIOS flash update process. The computer may not boot if you turn off your computer.

Steps

1. Go to [Dell Support Site](#).
2. Go to **Identify your product or ask support**. In the box, enter the product identifier, model, service request or describe what you are looking for, and then click **Search**.

 **NOTE:** If you do not have the Service Tag, click **Detect This PC**. The site automatically detects your device, and you can then click **Explore Product Support** to go to the support page for your device. You can also use the product ID or manually browse for your computer model.

3. Click **Drivers & Downloads**.
4. Select the operating system installed on your computer.
5. In the **Category** drop-down list, select **BIOS**.
6. Select the latest version of BIOS, and click **Download** to download the BIOS file for your computer.

7. After the download is complete, navigate to the folder where the BIOS update file has been saved.
8. Double-click the BIOS update file and follow the on-screen instructions.
For more information, search in the Knowledge Base Resource at [Dell Support Site](#).

Updating the BIOS using the USB drive in Windows

About this task

 **CAUTION:** If BitLocker is not suspended before updating the BIOS, the BitLocker key is not recognized the next time you reboot the computer. You will then be prompted to enter the recovery key to proceed, and the computer displays a prompt for the recovery key on each reboot. Failure to provide the recovery key can result in data loss or an operating system reinstall. For more information, see the Knowledge Base Resource [Updating the BIOS on Dell systems with BitLocker enabled](#).

 **CAUTION:** Do not turn off the computer during the BIOS flash update process. The computer may not boot if you turn off your computer.

Steps

1. Go to [Dell Support Site](#).
2. Go to **Identify your product or ask support**. In the box, enter the product identifier, model, service request or describe what you are looking for, and then click **Search**.
 **NOTE:** If you do not have the Service Tag, click **Detect This PC**. The site automatically detects your device, and you can then click **Explore Product Support** to go to the support page for your device. You can also use the product ID or manually browse for your computer model.
3. Click **Drivers & Downloads**.
4. Select the operating system installed on your computer.
5. In the **Category** drop-down list, select **BIOS**.
6. Select the latest version of BIOS, and click **Download** to download the BIOS file for your computer.
7. Create a bootable USB drive. For more information, search the Knowledge Base Resource at [Dell Support Site](#).
8. Copy the BIOS Setup program file to the bootable USB drive.
9. Connect the bootable USB drive to the computer that needs the BIOS update.
10. Restart the computer and press **F12**.
11. Select the USB drive from the **One Time Boot Menu**.
12. Type the BIOS Setup program filename and press **Enter**.
The **BIOS Update Utility** appears.
13. Follow the on-screen instructions to complete the BIOS update.

Updating the BIOS in Linux and Ubuntu

To update the system BIOS on a computer that is installed with Linux or Ubuntu, see [How to Update the Dell BIOS in the Ubuntu or Linux Environment](#) at [Dell Support Site](#).

Updating the BIOS from the One-Time boot menu

To update the BIOS from the One-Time boot menu, see Knowledge base article [000128928](#) at [Dell Support Site](#).

System and setup password

 **CAUTION:** The password features provide a basic level of security for the data on your computer.

CAUTION: Ensure that your computer is locked when it is not in use. Anyone can access the data that is stored on your computer, when left unattended.

Table 45. System and setup password

Password type	Description
System password	Password that you must enter to boot to your operating system.
Setup password	Password that you must enter to access and change the BIOS settings of your computer.

You can create a system password and a setup password to secure your computer.

NOTE: The System and setup password feature is disabled by default.

Assigning a System Setup password

Prerequisites

You can assign a new System or Admin Password only when the status is set to **Not Set**. To enter BIOS System Setup, press F2 immediately after a power-on or reboot.

Steps

- To enter the **System Setup**, press **F2** immediately after a power-on or reboot.
- In the **System BIOS** or **System Setup** screen, select **Security** and press Enter. The **Security** screen is displayed.
- Select **System/Admin Password** and create a password in the **Enter the new password** field. Use the following guidelines to create the system password:
 - Password can be up to 32 characters.
 - Password must contain at least one special character: "(! " # \$ % & ' * + , - . / : ; < = > ? @ [\] ^ _ ` { | })"
 - The password can contain numbers from 0 to 9.
 - The password can contain alphabets A to Z and a to z.
- Type the system password that you entered earlier in the **Confirm new password** field and click **OK**.
- Press Y to save the changes. The computer restarts.

Deleting or changing an existing system password or setup password

Prerequisites

Ensure that the **Password Status** is Unlocked in the System Setup before attempting to delete or change the existing system password and/or setup password. You cannot delete or change an existing system password or setup password if the **Password Status** is Locked. To enter the System Setup, press F2 immediately after a power-on or reboot.

Steps

- To enter the **System Setup**, press **F2** immediately after a power-on or reboot.
- In the **System BIOS** or **System Setup** screen, select **System Security** and press Enter. The **System Security** screen is displayed.
- In the **System Security** screen, verify that the **Password Status** is Unlocked.
- Select **System Password**. Update or delete the existing system password, and press Enter or Tab.
- Select **Setup Password**. Update or delete the existing setup password, and press Enter or Tab.

 **NOTE:** If you change the system password and/or setup password, reenter the new password when prompted. If you delete the system password and/or setup password, confirm the deletion when prompted.

6. Press Esc. A message prompts you to save the changes.
7. Press Y to save the changes and exit from **System Setup**.
The computer restarts.

Clearing system and setup passwords

About this task

To clear the system or setup passwords, contact Dell technical support as described at [Contact Support](#).

 **NOTE:** For information about how to reset Windows or application passwords, see the documentation accompanying Windows or your application.

Troubleshooting

Handling swollen rechargeable Li-ion batteries

Like most laptops, Dell laptops use Lithium-ion batteries. One type of Lithium-ion battery is the rechargeable Li-ion battery. Rechargeable Li-ion batteries have increased in popularity in recent years and have become a standard in the electronics industry due to customer preferences for a slim form factor (especially with newer ultra-thin laptops) and long battery life. Inherent to rechargeable Li-ion battery technology is the potential for swelling of the battery cells.

A swollen battery may impact the performance of the laptop. To prevent possible further damage to the device enclosure or internal components leading to malfunction, discontinue the use of the laptop and discharge it by disconnecting the AC adapter and letting the battery drain.

Swollen batteries should not be used and must be replaced and disposed of properly. We recommend contacting Dell Support for options to replace a swollen battery under the terms of the applicable warranty or service contract, including options for replacement by a Dell authorized service technician.

The guidelines for handling and replacing rechargeable Li-ion batteries are as follows:

- Exercise caution when handling rechargeable Li-ion batteries.
- Discharge the battery before removing it from the laptop. To discharge the battery, unplug the AC adapter from the computer and operate the computer only on battery power. The battery is fully discharged when the computer no longer turns on when the power button is pressed.
- Do not crush, drop, mutilate, or penetrate the battery with foreign objects.
- Do not expose the battery to high temperatures, or disassemble battery packs and cells.
- Do not apply pressure to the surface of the battery.
- Do not bend the battery.
- Do not use tools of any type to pry on or against the battery.
- If a battery gets stuck in a device as a result of swelling, do not try to free it as puncturing, bending, or crushing a battery can be dangerous.
- Do not attempt to reassemble a damaged or swollen battery into a laptop.
- Swollen batteries that are covered under warranty should be returned to Dell in an approved shipping container (provided by Dell)—this is to comply with transportation regulations. Swollen batteries that are not covered under warranty should be disposed of at an approved recycling center. Contact Dell Support at [Dell Support Site](#) for assistance and further instructions.
- Using a non-Dell or incompatible battery may increase the risk of fire or explosion. Replace the battery only with a compatible battery purchased from Dell that is designed to work with your Dell computer. Do not use a battery from other computers with your computer. Always purchase genuine batteries from [Dell Site](#) or otherwise directly from Dell.

Rechargeable Li-ion batteries can swell for various reasons such as age, number of charge cycles, or exposure to high heat. For more information about how to improve the performance and lifespan of the laptop battery and to minimize the possibility of occurrence of the issue, search Dell laptop battery at [Dell Support Site](#).

Dell SupportAssist Pre-boot System Performance Check diagnostics

About this task

SupportAssist diagnostics (also known as system diagnostics) performs a complete check of your hardware. The Dell SupportAssist Pre-boot System Performance Check diagnostics is embedded within the BIOS and launched by the BIOS internally. The embedded system diagnostics provides options for particular devices or device groups allowing you to:

- Run tests automatically or in an interactive mode.
- Repeat the tests.
- Display or save test results.
- Run thorough tests to add more options and obtain details about any failed devices.

- View status messages that inform you when the tests are completed successfully.
- View error messages that inform you of problems encountered during testing.

NOTE: Some tests for specific devices require user interaction. Always ensure that you are present at the computer when the diagnostic tests are performed.

For more information, see [How to Run Dell Preboot Diagnostics and Hardware Tests on Your Dell Computer](#).

Running the SupportAssist Pre-Boot System Performance Check

Steps

1. Turn on your computer.
2. As the computer boots, press the F12 key.
3. On the boot menu screen, select **Diagnostics**.
The diagnostic quick test begins.
NOTE: For more information about running the SupportAssist Pre-Boot System Performance Check on a specific device, see [Dell Support Site](#).
4. If there are any issues, error codes are displayed.
Note the error code and validation number and contact Dell.

Built-in self-test (BIST)

Motherboard Built-In Self-Test (M-BIST)

M-BIST is the system board onboard self-test diagnostics tool that improves the diagnostics accuracy of system board Embedded Controller (EC) failures.

NOTE: M-BIST can be manually initiated before Power On Self-Test (POST).

How to run M-BIST

NOTE: Before initiating M-BIST, ensure that the computer is in a power-off state.

1. Press and hold both the **M** key and the power button to initiate M-BIST.
2. The battery indicator LED may exhibit two states:
 - Off: No fault was detected.
 - Amber and White: Indicates a problem with the system board.
3. If there is a failure with the system board, the battery status LED flashes one of the following error codes for 30 seconds:

Table 46. LED error codes

Blinking Pattern		Possible Problem
Amber	White	
1	1	TPM detection failure
1	4	Hinge cable overcurrent protection (OCP) is triggered. The hinge cable may be damaged.
2	1	CPU configuration or CPU failure
2	4	Memory or Random-Access Memory (RAM) failure
4	4	Display power-rail failure on the system board

4. If there is no failure with the system board, the LCD cycles through the solid color screens (that are described in the LCD-BIST) for 30 seconds and then turn off.

Logic Built-in Self-test (L-BIST)

L-BIST is an enhancement to the single LED error code diagnostics and is automatically initiated during POST. L-BIST checks the power that is supplied to the LCD panel. If there is no power being supplied to the LCD panel (that is if the L-BIST circuit fails), the battery status LED flashes either an error code [1,4], [2,7], or [4,4].

 **NOTE:** If L-BIST fails, LCD-BIST cannot function as no power will be supplied to the LCD panel.

How to invoke the L-BIST

1. Turn on your computer.
2. If the computer does not start up normally, observe the light patterns of the battery-status light:
 - If the battery status light flashes an error code [1,4] or [2,7], the display cable may not be connected properly.
 - If the battery status light flashes an error code [4,4], there is a failure on the LCD power rail of the system board, hence there is no power that is supplied to the LCD.
3. For cases, when a [1,4] or [2,7] error code is shown, check to see if the display cable is properly connected.
4. For cases when a [4,4] error code is shown, replace the system board.

LCD Built-in Self-Test (LCD-BIST)

Dell laptops have a built-in diagnostic tool that helps you determine if the screen abnormality you are experiencing is an inherent problem with the LCD (screen) of the Dell laptop or with the video card (GPU) and computer settings.

When you notice screen abnormalities like flickering, distortion, clarity issues, fuzzy or blurry image, horizontal or vertical lines, color fade, it is always a good practice to isolate the LCD (screen) by running the LCD-BIST.

How to invoke the LCD-BIST

1. Turn off your computer.
2. Disconnect any peripherals that are connected to the computer. Connect only the AC adapter (charger) to the computer.
3. Ensure that the LCD (screen) is clean (no dust particles on the surface of the screen).
4. Press and hold the **D** key and press the power button to enter LCD-BIST mode. Continue to hold the **D** key until the computer boots up.
5. The screen displays solid colors and changes colors on the entire screen to white, black, red, green, and blue twice.
6. Then it displays the colors white, black, and red.
7. Carefully inspect the screen for abnormalities (any lines, fuzzy color, or distortion on the screen).
8. At the end of the last solid color (red), the computer shuts down.

 **NOTE:** Dell SupportAssist Preboot diagnostics upon launch initiates an LCD-BIST first, expecting a user intervention to confirm functionality of the LCD.

System-diagnostic lights

This section lists the system-diagnostic lights of your Alienware 16 Aurora AC16250.

 **NOTE:** The battery-status light shows the SERVICE LED system-diagnostic light codes.

The following table shows different Service LED blinking patterns and associated problems. The diagnostic light codes consist of a two-digit number, and the digits are separated by a comma. The number stands for a blinking pattern; the first digit shows the number of blinks in amber color, and the second digit shows the number of blinks in white color. The Service LED blinks in the following manner:

- The Service LED blinks the number of times equal to the value of the first digit and turns off with a short pause.
- After that, the Service LED blinks the number of times equal to the value of the second digit.

- The Service LED turns off again with a longer pause.
- After the second pause, the blinking pattern will be repeated.

Table 47. Diagnostic light codes

Diagnostic light codes (Amber, White)	Problem description
1,1	TPM detection failure
1,3	The camera-cable overcurrent protection (OCP1) was triggered. The camera module along with its cable may be damaged.
1,4	The hinge-cable overcurrent protection (OCP) was triggered. The hinge cable may be damaged.
1,6	Generic catch-all for ungraceful EC code flow errors
1,8	Chipset "Catastrophic Error" signal has tripped
2,1	CPU configuration or CPU failure
2,3	No memory or Random-Access Memory (RAM) detected
2,4	Memory or Random-Access Memory (RAM) failure
2,5	Invalid memory installed
2,6	System board or Chipset Error
2,7	LCD failure SBIOS message
3,2	PCI of Video card/chip failure
3,3	Recovery image not found
3,4	Recovery image found but invalid
3,5	EC power-rail error
3,6	Flash corruption detected by SBIOS
3,7	Timeout waiting on Management Engine (ME) to reply to HECI message
4,1	Temporary battery failure
4,4	Cable and power-rail failure

Recovering the operating system

When your computer is unable to boot to the operating system even after repeated attempts, it automatically starts Dell SupportAssist OS Recovery.

Dell SupportAssist OS Recovery is a stand-alone tool that is preinstalled on Dell computers running the Windows operating system. It consists of tools to diagnose and troubleshoot issues that may occur before your computer boots to the operating system. It enables you to diagnose hardware issues, repair your computer, back up your files, and restore your computer to its factory state.

You can also download it from the Dell Support website to troubleshoot and fix your computer when it fails to boot into the primary operating system due to software or hardware failures.

For more information about the Dell SupportAssist OS Recovery, see *Dell SupportAssist OS Recovery User's Guide* at [Serviceability Tools at the Dell Support Site](#). Click **SupportAssist** and then click **SupportAssist OS Recovery**.

 **NOTE:** Windows 11 IoT Enterprise LTSC 2024 and Dell ThinOS 10 do not support Dell SupportAssist. For more information about recovering ThinOS 10, see [Recovery mode using R-Key](#).

Real-Time Clock (RTC Reset)

The Real-Time Clock (RTC) reset function enables you or the service technician to recover Dell computers from No POST/No Power/No Boot situations.

Start the RTC reset with the computer powered off and connected to AC power. Press and hold the power button for twenty-five seconds or until you see the LED indicator blinking two to three times. The computer RTC Reset occurs after you release the power button.

Backup media and recovery options

It is recommended to create a recovery drive to troubleshoot and fix problems that may occur with Windows. Dell provides multiple options for recovering the Windows operating system on your Dell computer. For more information, see [Dell Windows Backup Media and Recovery Options](#).

Network power cycle

About this task

If your computer is unable to access the Internet due to network connectivity issues, reset your network devices by performing the following steps:

Steps

1. Turn off the computer.
2. Turn off the modem.
 **NOTE:** Some Internet service providers (ISPs) provide a modem and router combo device.
3. Turn off the wireless router.
4. Wait for 30 seconds.
5. Turn on the wireless router.
6. Turn on the modem.
7. Turn on the computer.

Drain flea power (perform hard reset)

About this task

Flea power is the residual static electricity that remains in the computer even after it has been powered off and the battery is removed.

For your safety, and to protect the sensitive electronic components in your computer, you must drain residual flea power before removing or replacing any components in your computer.

Draining flea power, also known as performing a "hard reset," is also a common troubleshooting step if your computer does not turn on or boot into the operating system.

Perform the following steps to drain the flea power:

Steps

1. Turn off the computer.
2. Disconnect the power adapter from the computer.
3. Remove the base cover.
4. Remove the battery.
5. Press and hold the power button for 20 seconds to drain the flea power.
6. Install the battery.
7. Install the base cover.
8. Connect the power adapter to the computer.
9. Turn on the computer.

 **NOTE:** For more information about performing a hard reset, go to [Dell Support Site](#). On the menu bar at the top of the Support page, select Support > Support Library. In the Search field on the Support Library page, type the keyword, topic, or model number, and then click or tap the search icon to view the related articles.

Getting help and contacting Alienware

Self-help resources

You can get information and help on Alienware products and services using these online self-help resources:

Table 48. Alienware products and online self-help resources

Self-help resources	Resource location
Information about Alienware products and services	Alienware Support Site
Contact Support	In Windows search, type Contact Support , and press Enter .
Online help for operating system	Windows Support Site
Access top solutions, diagnostics, drivers and downloads, and learn more about your computer through videos, manuals, and documents.	Your Alienware computer is uniquely identified by a Service Tag or Express Service Code. To view relevant support resources for your Dell computer, enter the Service Tag or Express Service Code at Dell Support Site . For more information about how to find the Service Tag for your computer, see Instructions on how to find your Service Tag or Serial Number .
Videos providing step-by-step instructions to service your computer.	Alienware Support Channel

Contacting Alienware

To contact Alienware for sales, technical support, or customer service issues, see [Alienware Support Site](#).

i **NOTE:** Availability of the services may vary depending on the country or region, and product.

i **NOTE:** If you do not have an active Internet connection, you can find contact information in your purchase invoice, packing slip, bill, or Dell product catalog.

Revision history

Tracks all updates that are made to the document. It typically includes the date of change, version number, and a brief description of the modification. This log helps maintain transparency, accountability, and a clear timeline of progress.

Table 49. Revision history

Revision	Date	Description
A05	February 2026	<ul style="list-style-type: none"> Updated the information about system-diagnostic lights. Added Quebec requirement information.
A03	September 2025	Add a note about the battery switch in the installation procedures for the base cover.
A02	August 2025	<ul style="list-style-type: none"> Update in the wireless module model number. Update in keyboard specifications to include Korean support. Update of removal and replacement procedures for the base cover. Update note in the storage specifications. Update content in the chapter Alienware Command Center.
A01	June 2025	Update in the display specifications.
A00	February 2025	Original publish date.